



THE ESSENTIAL REFERENCE GUIDE FOR FILMMAKERS

production

postproduction

distribution & exhibition

archive

Kodak

IDEAS AND TECHNOLOGY

AN INTRODUCTION TO THE ESSENTIAL REFERENCE GUIDE FOR FILMMAKERS

Good films—those that effectively communicate the desired message—are the result of an almost magical blend of ideas and technological ingredients. And with an understanding of the tools and techniques available to the filmmaker, you can truly realize your vision.

The “idea” ingredient is well documented, for beginner and professional alike. Books covering virtually all aspects of the aesthetics and mechanics of filmmaking abound—how to choose an appropriate film style, the importance of sound, how to write an effective film script, the basic elements of visual continuity, etc.

Although equally important, becoming fluent with the technological aspects of filmmaking can be intimidating. With that in mind, we have produced this book, *The Essential Reference Guide for Filmmakers*. In it you will find technical information—about light meters, cameras, light, film selection, postproduction, and workflows—in an easy-to-read-and-apply format.

Ours is a business that’s more than 100 years old, and from the beginning, Kodak has recognized that cinema is a form of artistic expression. Today’s cinematographers have at their disposal a variety of tools to assist them in manipulating and fine-tuning their images. And with all the changes taking place in film, digital, and hybrid technologies, you are involved with the entertainment industry at one of its most dynamic times.

As you enter the exciting world of cinematography, remember that Kodak is an absolute treasure trove of information, and we are here to assist you in your journey. Hopefully you will find this book useful—and we invite you to call upon us now and in the future for the technology, products and support you need to succeed.

TABLE OF CONTENTS

SECTION 1: AN INTRODUCTION TO MOTION PICTURE FILM AND ITS PRINCIPLES

Ideas and Technology.....	1
A Chronicle of the Motion Picture Industry.....	5
The Nature of Light and Color	19
Film Structure.....	29
Film Types and Formats.....	35
Basic Sensitometry and Characteristics of Film	49
Motion Picture Cameras and Lenses	63

SECTION 2: PRACTICAL GUIDES AND TECHNIQUES

Planning Your Workflow.....	73
Filmmaking Resources	77
Film Crew	83
Film Specifications.....	93
Film Storage and Handling.....	101
Exposing Film	109
Exposure Tools	115
Camera and Lighting Filters	123
Lighting.....	133
Processing	141
KODAK KEYCODE Numbers Technology.....	149
Optical Workflow	159
Digital Workflow.....	167

APPENDIX: FILMMAKER'S CHECKLIST

GLOSSARY OF MOTION-PICTURE TERMS

A CHRONICLE OF THE MOTION PICTURE INDUSTRY

INTRODUCTION

If you've ever taken a still photograph, you're already acquainted with the essentials of shooting a motion picture image. The biggest difference between the two is that the movie camera typically captures twenty-four images each second.

Well into the late Nineteenth Century, most images were captured on sensitized glass plates, metal, or heavy paper. Shortly after the invention of photography, attempts were already underway to capture and reproduce a moving image. Typically, an array of individual cameras, triggered in rapid succession, captured a series of single exposures on glass plates. These experiments relied on a persistence of vision concept—the eye-brain combination is capable of melding a series of sequential images into a movie. A more practical photographic system had yet to be created.

It was George Eastman's invention of the KODAK Camera, and the flexible film it exposed, that made the movie camera possible.

A HISTORY OF CINEMATOGRAPHY

Human fascination with the concept of communicating with light and shadows has its roots in antiquity. Aristotle supplied the earliest reference to the camera obscura—sunlight, passing through a small hole, projected an inverted image on the wall of a darkened room.

Renaissance artists traced that projected image to create accurate drawings. Gemma Frisius published a drawing of a camera obscura in 1545. Thirteen years later Giovanni Battista della Porta wrote "Magia Naturalis," a book describing the use of a camera obscura with lenses and concave mirrors to project a tableau in a darkened room. They might as well have been drawing pictures in sand, because the images were impermanent.

This phenomenon eventually led to the development of the early photographic camera—a simple box in which light struck a sensitive solution on a glass, metal, or paper base. The roots of modern photography trace back to 1816, when Nicephore Niepce, a French lithographer, recorded images on metal plates coated with a sensitized material. In 1827, he recorded a picture on a pewter plate coated with a light sensitive chemical emulsion.

Niepce subsequently collaborated with Louis Jacques Mande Daguerre in the development of the world's first practical photographic system. They recorded clear, sharp images on silverized copper plates in Daguerre's studio in 1837. Niepce gave his invention to the French government, which put it into the public domain.

William Henry Fox Talbot invented the first process for making positive prints from negative images during the 1830s. Richard Leach Maddox discovered that the silver halide crystal is an incredibly efficient repository for capturing light. His 1871 discovery was a crucial building block for modern photography.

Eadweard Muybridge, a vagabond photographer who migrated to California, made the oldest recorded attempt at motion picture photography. In 1872, California Governor Leland Stanford hired Muybridge to help him win a bet



1951 KODAK BROWNIE
Movie Camera



1923 KODACOLOR Film

by proving that there are times in a horse race when all four of the animal's feet are off the ground. Five years later, Muybridge set 24 cameras up in a row along a racetrack. He attached a string to each camera shutter and stretched the strings across the track. Muybridge chalked lines and numbers on a board behind the track to measure progress. As Stanford's horse ran the track, it tripped the wires and recorded 24 photographs that proved that all four of the horse's feet were off the ground at the same time.

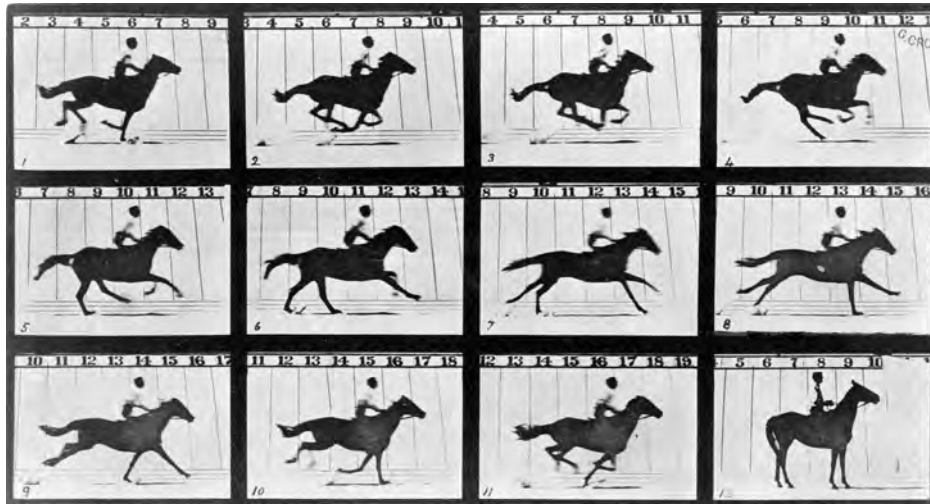

Stanford won his bet, and Muybridge continued experimenting. During the early 1880s, he traveled to Paris to demonstrate his multiple camera system for other photographers and scientists. One of his hosts was Etienne Jules Marey, who was experimenting with the use of a single camera for recording images in motion.

The camera had a long barrel that served as a lens, and a circular chamber containing a single glass photographic plate. It took Marey one second to record 12 images around the edge of the glass plate. He called his invention chronophotography. Marey recorded moving images of men running and jumping, horses trotting, and gulls flying. They were permanent records of one to two seconds of motion.

Concurrently, Thomas Edison invented a system that recorded and played back music using wax cylinders. After his invention became popular, Edison got an idea for building and selling a device to consumers that displayed moving images to accompany the music. In 1885 at his research laboratory in Menlo Park, New Jersey, he assigned W.K.L. Dickson the task of finding a way to record moving images on the edges of records.

Eventual Kodak founder George Eastman became interested in still photography in 1877, when he was a 25-year-old bank clerk in Rochester, New York. Photography was a cumbersome process; the photographer had to spread a chemical emulsion on a glass plate in a pitch-black area, and then capture the image before the emulsion dried.

In 1880, Eastman manufactured dry plates that maintained their sensitivity to light. EASTMAN Dry Plates played a major role in popularizing photography, but the former bank clerk was determined to make it even easier.

In England in 1887, Reverend Hannibal Goodwin invented and patented a way to coat light-sensitive photographic emulsion on a cellulose nitrate base. The base was strong, transparent, and thin enough to perfect a process for manufacturing film on a flexible base.

Eastman purchased the right to use that patent in 1888, and introduced the KODAK BROWNIE Camera the following year. The camera was pre-loaded with enough film for 100 pictures. The ad campaign promoted photography as a hobby for every man, woman and child; its byline: "You push the button, and we do the rest." The camera was mailed to Kodak after all the pictures were taken. Kodak processed and printed the film, then returned prints to the photographer along with a reloaded camera.

Dickson saw the BROWNIE Camera at an amateur photographers' club in New Jersey. He traveled to Rochester to meet with Eastman, who agreed to provide the film needed for an experimental motion picture camera. Dickson developed the Kinetograph camera and Kinetoscope projector, which Edison patented in the United States in 1891. Dickson wrote to Edison stating, "Eureka, this is it!" Edison replied, "Now, work like hell!"



1898 KODAK Folding
Pocket Camera

At that time KODAK Camera Film was manufactured in 70 mm wide rolls. The rolls were long enough to make 100 round exposures, each about two inches in diameter. Dickson determined that Kodak film, if sliced in half lengthwise to a 35 mm width, would be far more manageable in the new camera. Eastman supplied the film, which was perforated on both film edges, sixty-four times per foot, to engage with the Kinetograph camera's sprockets. These basic physical specifications remain the world standard for cinematography and theatrical exhibition.

A hand crank drove the Kinetograph camera. It was determined that a frame rate of about sixteen images per second would yield satisfactory moving pictures when viewed. Accordingly, the camera made eight exposures for every revolution of the crank, and two turns per second became the standard operating procedure until the advent of sound film. The actual size of the film frame was 24 mm wide by 18 mm tall. The camera was brilliantly simple. Then (as now) 35 mm film has sixteen photographic frames per foot of film. Accordingly, the length of film footage during the Silent Era was equal to the movie's running time in seconds.

After exposure, the light-sensitive film was unloaded and developed in a conventional darkroom. The resulting negative was placed in contact with fresh, unexposed film and then, still in the darkroom, exposed through the negative under controlled light. After development, the resulting positive print was ready for viewing.

On May 20, 1891, Edison demonstrated his projector for the first time when delegates from the National Federation of Women's Clubs visited the company's research laboratory. A reporter for The New York Sun wrote, "The women saw a small pine box with a peephole about an inch in diameter. One by one, they looked through the peephole and saw moving images of a man, smiling, waving, taking off his hat, and bowing with naturalness and grace."

In 1892, Edison opened a crude movie studio in Orange, New Jersey, and told Dickson to begin producing motion pictures there for a big debut at the 1894 Chicago Exposition. Edison named it the Black Maria Studio, because of its resemblance to the shape of so-named horse-drawn police carts. The roof could be removed to let in daylight, and the studio was built on a turntable that was revolved to follow the sun. Dickson installed a trolley track at the studio that enabled him to move the camera further away from and closer to his subjects for more interesting shots—an early, intuitive step towards making cinematography an interpretive art.

The Kinetoscope was a sensation at the Exposition. That same year, Edison made a business deal with Norman Charles Raff, who organized The Kinetoscope Company and sold territorial rights to entrepreneurs who wanted to operate peep show parlors. Soon, more than 1,000 parlors operated in the U.S. and Canada.

Record of a Sneeze, shot by Dickson, is the oldest motion picture on record at the Library of Congress. The title of the 1893 film is literal; it shows Fred Ott, a mechanic who worked for Edison, sneezing.



Although Kinetoscope movies were only 20 seconds long, more than 1,000 Kinetoscopes were sold between 1894 and 1895 in North America and Europe. It is said that Edison did not see any applications for movies apart from these peep shows.

THE BOX OFFICE IS BORN

In 1894, French brothers Louis and Auguste Lumière saw a Kinetoscope demonstration. It inspired them to invent a combination motion picture projector and camera called the Cinématographe, a Greek word meaning writing with light and motion.

Thomas Edison was one of the first inventors to realize the potential that a flexible ribbon of film offered for capturing sequential images. His camera moved a small area of film into position behind a shuttered lens, held it steady for a split second as the shutter opened and closed to expose the film, accurately advanced the film, and then repeated the whole process many times per second. To this day, Edison's creation is the basis for all motion picture film cameras, in all formats.

The Lumière brothers presented eight short films at the Grande Café in Paris on December 28, 1895. It was the first time an audience paid to see movies projected on a screen. One showed workers leaving a factory at the end of the day; another showed an approaching train.

In February 1896, Thomas Armat and C. Francis Jenkins patented the Vitascope motion picture projector, then requested a supply of film from Edison. Edison asked to see a demonstration of the projector. Afterwards, an agreement was reached to sell the Vitascope projector under Edison's name.

The first public screening was on April 23, 1896, at Koster & Bial's Music Hall at 34th Street and Broadway in Manhattan. There were 12 short films augmenting vaudeville acts, and these included a boxing match, a serpentine dance, the German emperor reviewing his troops, and one called *Rough Sea at Dover*. A reporter for a local newspaper wrote enthusiastically about the experience shared by the audience of strangers, sitting in a dark theater, watching moving images projected on a screen: "The second film represented the breaking of waves on the seashore. Wave after wave came tumbling on the sand, and as they struck, broke into tiny floods just like the

real thing. Some people in the front row seemed to be afraid they were going to get wet, and looked to see where they could run, in case the waves came too close."

Edison granted brothers Andrew and George Holland sole marketing rights to the Vitascope projector in Canada. The first screening was staged in West End Park in Ottawa on July 21, 1896. Nearly 1,200 spectators saw a magic show, followed by a series of short films. The hit of the evening was *The Kiss*, a brief film featuring Canadian actress May Irwin and actor John Rice, co-stars of a popular Broadway play, *The Widow Jones*. The kiss in question was really just a quick peck on the cheek, but the scene had been scandalizing Broadway audiences. With the magic of film, people everywhere could share in the shock. The almost immediate commercial success of motion picture entertainment was startling.

Innovative still photographers such as George Melies were just discovering the real power of this fledgling medium. This sometimes-political cartoonist, actor, and magician was intrigued by the storytelling potential of film. In the early 1900s, Melies developed the concept of "artificially arranged scenes." Taking his guide from the world of theatre, he created the events needed to tell his story with actors and appropriate settings rather than relying upon randomly recorded events. This new approach to reality opened doors to creative storytelling and resulted in a prolific and successful career for Melies. His 400th film, *A Trip to the Moon* (1902), was enormously popular.

THE POWER OF EDITING

Edwin Porter was an ex-sailor who installed and operated the Vitascope projector for the Holland brothers. He spent the next three years on a barnstorming tour showing short films in Canada and Central and South America. Edison hired him to direct and shoot short films at the company's new glass-enclosed studio in Manhattan in 1900. By then, Edison owned copyrights to some 500 short films, including many shot by roving freelance cinematographers.

Porter's brainchild was creative editing, a facet of motion picture production that we take for granted today. Until he came on the scene in the early 1900s, no one had edited films; they simply shot footage and projected the results. Porter experimented with creating a grammar for visual storytelling by moving the camera to alter the audience's point of view. He intercut parallel scenes, created double exposures, and combined live action in the foreground with painted and projected backgrounds.

Inspired by the innovative use of theatrical staging techniques and varied camera angles he observed in Melies' films, Porter set out to tell a story using footage he had already shot. He recognized that the filmmaker had the same freedom in developing a fictional world that had long been available to the novelist and dramatist—the ability to change scenes quickly, to flash backward and forward in time, to show simultaneous actions, etc. With this newfound flexibility in film editing came another revelation that simplified the production process—that scenes in a particular film do not have to be shot in a projection sequence; they can always be reassembled later for maximum impact.

Porter went on to direct Mary Pickford and many other great stars. He made spectaculars on location (*The Eternal City*), and left his indelible stamp on this fast-growing business before retiring in 1915. His 12-minute 1903 drama, *The Great Train Robbery*, was one of the most successful narrative films made during that period. In 1907, Porter hired a stage actor named D.W. Griffith to appear in a film called *Rescued from an Eagle's Nest*. Griffith soon became a director, who completed his first film the following year. With that film a 16-year collaboration with "Billy" Bitzer began.

Billy Bitzer was an electrician who began his career shooting scenic footage of the Canadian outback during the late 1890s, films sponsored by the Canadian National Railroad. The films were shown in England to attract settlers to the outback. Bitzer's co-ventures with Griffith included such landmark dramas as *The Birth of a Nation*, *Intolerance*, and *Broken Blossoms*. He pioneered the use of cinematic storytelling techniques in those and other films, including close ups, soft focus, fade outs, and backlighting. In 1913, Bitzer installed an iris diaphragm in his personal camera, which enabled him to go to black between scenes. He and Griffith first used that technique while they were filming *The Battle at Elderbush Gulch*. Bitzer also used the iris diaphragm to subtly sharpen the focus on characters and actions in the background. Bitzer and others in the first generation of cinematographers were inventing a new language.

MOVIE MAGIC

In 1919, 21-year-old George Folsey shot his first film, *His Bridal Night*. Alice Brady played twins in her dual role. An ingenious idea in its day, Folsey's low-tech solution consisted of black velvet taped over half of the lens while Brady played one twin. Then, he rewound the film, moved the velvet to cover the other half of the lens, and re-shot the scene with Brady playing the other twin. It worked beautifully.

All motion pictures at that time were produced on black-and-white orthochromatic film that was only sensitive to blue or violet light. Colors in other light recorded as black. Makeup was used to offset the limitation, but sometime actors often appeared unnaturally. Kodak heeded cinematographers' suggestions in 1922, and developed a panchromatic black-and-white film that recorded all colors and reproduced each of them in accurate gray tones.

By the mid 1920s, Europe began clamoring for Hollywood films while the homegrown industry recovered from war. Hollywood studios adopted the practice of having two cinematographers operate cameras side by side. The negative from one camera was edited and used for producing prints for domestic release. The negative from the second camera was edited and shipped to labs in Europe that produced release prints for that continent. For this purpose, Kodak developed a high quality duplicate negative film in 1926. That development sparked a breakthrough in the evolution of the art of cinematography: the second cameramen became operators, freeing cinematographers to concentrate on lighting and creativity.

AND THEN THERE WAS SOUND

By the mid-1920s, the public's fascination with radio had noticeably affected box office receipts at the movies. Although soap operas were not yet thought of, radio plays were occasionally broadcast in addition to live music and a hodgepodge of other offerings. A few far-sighted individuals took notice of the growing menace.

Thomas Edison invented sound recording in 1877 with the intention that sound accompany film from the beginning. The technology was slow to develop. Several engineers in the 1920s experimented with radio amplifiers as a means of reproducing sound for movies, but none were adequate for use in large movie theaters.

Finally, in 1926, Warner Bros. Studio developed a sound system that produced volume at a level that was adequate even for movie palaces. Their first offering using the new medium was *Don Juan*. It had a musical soundtrack via a phonograph record, which was mechanically linked to the movie projector in the theater. They named their system Vitaphone.

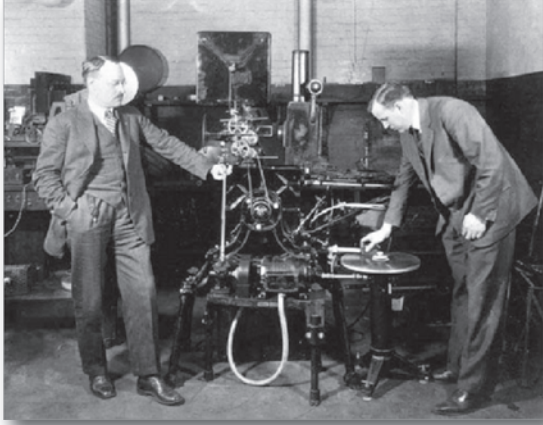

One of the earliest synchronized sound systems was the Vitaphone disc system. Introduced in 1927, this employed large 16-inch diameter phonograph discs which were played from the center outwards on a turntable attached to the film projector with the drive mechanically synchronized to the film gate. The trick was to ensure re-synchronization at the start of each film reel and disc. This required the projectionist to develop the skill to flick the stylus to the exact groove.

In order to produce sufficient sound fidelity and consistency, the hand-cranked cameras were fitted with electric motors that ran at a constant speed of 24 frames per second, rather than the familiar 16 fps. Another important advantage, at 24 frames per second, the flicker characteristic of silent films disappeared. The smooth image gave the audience about 50 percent more image information to absorb.

The success of *Don Juan* convinced Warner Bros. to take their system a little further, adding synchronized speech and singing to the picture, still using phonographic recordings. Their first effort, 1927's *The Jazz Singer*, had a weak story, but because of its brief use of sound, it broke box office records. It was so successful that all major film studios rushed to create sound departments of their own.

Soon, the public shunned silent films in lieu of anything with sound. In many instances, the studios pulled back expensive silent features and hastily added sound—any sound—in order to release it as a talking picture. With few exceptions, scripts were now written exclusively for “talking pictures.”

The use of phonograph records for sound recording and reproduction was short-lived. The discs wore out quickly and broke easily. Maintaining synchronization required skill during projection and often failed. Film technicians created a way of recording the sound along the edge of the film; they designed a tiny photographic representation of the actual sound wave with light. The projectors designed for this process used a tiny light bulb and photoelectric cell to recover the sound energy and feed it to the theater amplifier.

This system eliminated the need for recorded discs, and it didn't wear out or lose synchronization. Eighty years later, this basic technique is still in use, albeit in a much improved form.

Sound created enormous technical problems for the cinematographer. Contemporary cameras were too noisy. The short-term solution was to enclose them in something like a large telephone booth, large enough to hold the operator, director and, sometimes, other assistants. That solved the noise problem, but it made the camera immobile. Some cinematographers tried putting wheels on the booths, but the problem was finally solved with the “barney,” a flexible covering for the camera that muffled camera noise.

Nor could actors move. Because the early microphone picked up every sound, wanted or not, the actors were forced to stand still and speak their lines toward where the microphone was hidden.

Musicals seemed the obvious venue for exploiting sound, and the public was inundated with them during those first few years. The immobility of the camera and the actors required that any dancing remain fairly stationary. Actors spoke and actors sang, but sound recording was so primitive that even great voices sounded bad.

In the end, though, the desire for quality musicals advanced sound technology. Busby Berkley's *42nd Street* was one of the earliest examples of effective post-sync recording; all musical recording was done in a sound studio, and then the actors lip-synced (or tap danced) along with a playback during filming. Thus the camera and the actors were free to perform naturally.

In addition to sound, major studios were experimenting with color and wide-film formats. Every studio had a proprietary wide-film system. A 1930 article in the *Cinematographic Annual*: "One of the outstanding developments of the past year in the motion picture industry has been the introduction of wide film. Even the advent of sound created no greater flurry of excitement." The economic depression of the 1930s, however, stifled further progress. Saddled with the cost of upgrading to talkies, exhibitors resisted investing in specialized projection systems for wide-screen presentations.



The collaboration between George Eastman and Thomas Alva Edison was crucial in establishing the basic technology of the motion picture system.

PUSH, PULL, AND KOOKALARIS

Charles Lang, ASC, was shooting *Shopworn Angel*, an early sound film, in 1929. Within a few days, the director told Lang that everyone was disappointed with his work, and that he was going to be replaced if things didn't change soon. "I did a lot of thinking that night, and decided the problem was that I was trying to emulate Arthur Miller and other cinematographers whose work I admired," Lang said. "I decided that I had to think for myself and trust my own instincts."

Lang earned the first of 18 OSCAR nominations from his peers in 1931. The following year, while shooting Helen Hayes in *A Farewell to Arms*, Lang was told to make her beauty sparkle. He approached that task like an artist painting a portrait. Lang took the back off the camera and used an amber filter to view the images that he was going to compose. The filter enabled him to previsualize in black and white. With his newfound perspective, he created backlight, hair light, and subdued soft light on Hayes' face. Lang also personally ground the glass filters that he used along with bits of gauze to soften the images. *A Farewell to Arms* won Lang his only OSCAR.

Later in his career, George Folsey, ASC, reflected on that seminal period. "We didn't have published film speeds or light meters," he said. "You trusted your eye. You could go to the lab on the studio lot, and ask them to pull a rack containing your film out of the tank, and look at it in safelight. You would say, push it back in for another moment or two. Then we'd say pull it out again." Thus, the now-familiar terms push and pull.

Folsey told another story about the invention of the "kookaloris." While shooting a scene with an actor who was wearing a white shirt, he wanted to separate the skin tones on the actor's face from the hue of the shirt. Folsey told a grip to hold a stepladder in front of a key light to create a shadow on the actor's shirt. The closer that the ladder was held to the light, the softer and less defined the shadow became. The grip eventually tired of holding

the ladder, so he cut a grill with the same pattern in a sheet of light wood. One day, Folsey visited Hal Rosson, ASC, who was shooting on another set. In the scene, an actress was lying on a bed swathed in white sheets. Rosson used Folsey's wooden grill to create some shadows, which made the scene more dramatic. Later, while shooting a similar situation, Rosson asked Folsey, "Where's that kookaloris thing?" The evolution of cinematography is filled with similar stories.

TECHNICOLOR, CINEMASCOPE, 3D, DISH NIGHT, AND TRIPLE FEATURES

Many early filmmakers tinted portions of their films for dramatic impact. But emulsion tinting was an expensive and time-consuming technique.

In 1922, the Technicolor process was introduced. Initially a two color process, two rolls of black-and-white film were simultaneously exposed. One was sensitized to red light, and the other to green light. Both films were processed and printed onto blank film and dyes were used to match the original colors. The first feature produced in that format was *The Toll of the Sea*, starring Anna May Wong. Throughout the 1920s, two-strip Technicolor was used selectively to visually punctuate individual scenes in some films.

In 1932 Technicolor announced a new three-color process that was simpler and less expensive than the earlier two-color process. One of the first to exploit the new process in his animated films, Walt Disney produced his *Three Little Pigs* in 1933. *Becky Sharp* (1935) was the first three-strip Technicolor feature film.



Released in 1935, *Becky Sharp* was the first three-strip Technicolor feature film. Three-strip Technicolor became the color standard for movie-making around the world, even though the required camera's large size made it a cumbersome process to work with.

The bulky filming equipment and complicated processing requirements of the Technicolor three-color imbibition process produced excellent results, but remained technically troublesome. In 1950, Kodak announced its first EASTMAN Color Negative Film, along with a complementary positive print film, that could record all three primary colors on the same strip of film. It was the beginning of a rapid transformation from black-and-white to color movies. Since then, color motion picture production has literally been available to anyone with a camera.



In 1950 Kodak introduced the Eastman Color single-strip system. The negative had special color couplers incorporated into the emulsion that reacted with developers to form dyes. This system would soon revolutionize color filmmaking around the world.

The studios also focused on differentiating motion pictures from television by making movie-going a unique entertainment experience. The first successful 3-D movie, appeared in 1952. As the major studios struggled to compete with black-and-white television at home, nearly forty 3-D movies were produced in 1953, and another 20 were started the following year. Only a few of those, however, were actually released in 3-D format. There are different theories given for 3-D's eventual demise. Some critics said that the format wasn't conducive to dramatic storytelling, and that it relied too much on gimmicks. Film audiences complained about the heavy glasses they had to wear, and claimed that 3-D gave them headaches and caused eye strain, problems typically caused by misaligned projectors.

The brief flirtation with 3-D movies led to the use of 65 mm and other wide format films that were screened in 70 mm format and augmented with stereo sound. More than sixty successful wide-format films were released between 1953 and 1970.

Throughout these years of innovation, however, theaters hedged their bets by handing out free dishes and offering triple features. Anything to push back the growing menace, television.

TELEVISION COMETH

The BBC experimented with television in the late 1920s. On July 13, 1930, The New York Times published an essay written by David Sarnoff, an executive at RCA and the NBC radio network and the future chairman of both organizations. Sarnoff predicted "radio-vision would be a theater in every home with cultural education and benefits for children."

Some progress was made during the 1930s, but World War II stalled television's future. After the war the television industry shifted into high gear. Most major studios kept their distance, but the more innovative among them organized separate TV production companies.



When a 2-inch videotape system was introduced in 1954, a Daily Variety headline proclaimed, "Film is Dead!" Lucille Ball and Desi Arnez didn't agree. They wanted a "movie look" for the now classic *I Love Lucy* television series. Desilu Productions hired Karl Freund, ASC to design and execute a cinematographic style and film look for the television series. He invented and perfected the technique of orchestrating three cameras while shooting in front of a live audience. One camera covered close-ups, while the other two filmed master shots from different angles. *I Love Lucy* was a runaway hit, and episodes have played in syndication around the world for more than half a century.

SUSPENDING REALITY

The ultimate objective of any movie-going experience is the ability that it provides the individual viewer to temporarily suspend reality and embrace an illusion on a two-dimensional screen. That requires some understanding of how people see the world. The human eye is an incredible imaging device capable of recording vast amounts of visual information in a wide range of colors. What we actually see is the density of light in the visible spectrum as it is reflected off people and objects in a field of view that stretches over a thirty-degree angle. Our brain translates the reflections of light, temporarily imprinted on our retinas during fleeting fractions of seconds, into a continuous stream of images. Conventional 35 mm movies projected at 24 frames a second are a reasonably close match to the human visual (eye/brain) system. The feeling of reality is more intense when there is additional visual information, as with a 70 mm print.

The human viewing system is also discretionary. People aren't locked in static positions watching images passing by. They are mobile in a world that is both spatial and temporal. Our view of the world is constantly moving in space and time. This explains the dual role that cinematographers play in providing the audience with a visual perspective. They must master the craft and play an interpretive, artistic role that requires making choices. They aren't just recording images. A cinematographer must probe beneath the surface and evoke an emotional response from the audience.

KODAK WAS THERE AT THE BEGINNING

From the beginning, filmmaking has been a global language. Kodak people have a unique place in that history, and they have a sincere appreciation for the artists who write with light on film. Kodak scientists have been listening and responding since W.K.L. Dickson described his needs for Edison's experimental camera. Every can of film you buy contains the cumulative knowledge of 120 years, so you become free to concentrate on the creative aspects of your filmmaking—not the technology required to make it work.

In 1966, Rune Ericson, a Swedish cinematographer, was preparing to shoot a feature film during a six-month journey around the world. He envisioned the need for a lightweight, mobile camera that could be handheld and used in tight spaces. Ericson planned to use a 16 mm camera, but he wasn't satisfied with the quality of the images when they were optically blown up to 35 mm film format. He asked Kodak to provide him with a supply of 16 mm film without perforations on one edge of the frame. That provided a 45-percent larger useable image area, and it also enabled Ericson to compose in the European wide screen 1.66:1 aspect ratio.

His experiment was temporarily put on hold when the picture was shelved. In 1970, Ericson modified an Éclair NPR camera, and Kodak provided a new fine grain negative film in 16 mm format with no perforations on one edge of the frame. Ericson shot *Lyckliga Skitar* in the new format, which was initially called the Runescape. With the recent rapid evolution of film, cameras, lenses and digital intermediate (DI) technologies, the Super 16 format has become an attractive alternative.

In 1982 cinematographer Daniel Pearl was contacted by an Australian director named Russell Mulcahy who wanted to chat about a new cable channel called MTV and something he called music videos. He spent the next eight years shooting scary movies for drive-in screens. Pearl was intrigued when Mulcahy told him that the “videos” would be artful interpretations of musical performances. Mulcahy said that they would be shooting 30 to 35 setups a day, but they would be able to fine-tune the images in the telecine suite.

That was a novel concept for Pearl because the Rank-Cintel telecine was a relatively new tool, which featured advanced imaging technology developed by Kodak scientists. Pearl embraced the concept, and pushed it to its limits while expanding the grammar of visual storytelling. He shot hundreds of music videos that won countless awards. However, Pearl also cautioned that the telecine suite was not a substitute for creating great images on the original negative.

“Woody” Omens, ASC, a three-time Emmy winner and six-time nominee, commented, “The negative is like the score of a symphony that can be interpreted in different ways in telecine.”

Throughout most of cinema history, cinematographers tended to work in the shadows rather than in the limelight. They were rarely mentioned in reviews and news articles. In 1986, the American Society of Cinematographers inaugurated the organization’s first Outstanding Achievement Awards celebration. ASC President Harry Wolf explained that the primary purpose was to let colleagues around the world know that their peers recognized and admired their artistry. He pointed out that members felt that it takes other cinematographers to recognize and appreciate all of the nuances integrated into artful cinematography.

AND THEN THERE WAS DIGITAL

Another giant step forward was taken in 1989 when Kodak invited some 20 cutting-edge cinematographers to meet with some of the company’s top imaging technology scientists to define the needs for developing digital postproduction technology that could be used for film restoration as well as for seamlessly compositing live action film with visual effects. A scientist at that meeting presciently predicted someday that it would be routine for cinematographers to extend their roles into “digital intermediate” postproduction suites to finalize film looks.

Kodak brought the Cineon digital film system to the marketplace in 1993. It included a digital film scanner and recorder, digital workstations, and software. Cineon was designed as an open system in order to encourage a broad, industry-wide evolution of new, compatible tools. It was resolution independent, because it took immense amounts of computer space and power to manage all of the data that 35 mm film was capable of recording. Kodak scientists estimated that it would take 40 megabytes of digital data to accurately represent the nuances in colors, contrast, and resolution that a single frame of 35 mm film was capable of capturing and storing. They envisioned a time when it would become more practical and affordable to scan and convert more or all the information stored on the negative in manageable digital files. They also anticipated increasing expectations for repurposing films for new markets.

Walt Disney Studios made the first use of the Cineon system in restoring the 1937 film classic *Snow White and the Seven Dwarfs* to its original splendor. There were many subsequent restoration projects and applications for the seamless integration of visual effects with live action film.

There were complimenting dramatic breakthroughs in the evolution of motion picture emulsion technology, beginning in 1996 with the introduction of the KODAK VISION Color Negative Films. Those films were designed with considerable advice from cinematographers around the world who defined their needs for finer-grained emulsions with specific imaging characteristics that gave them more latitude for creating artful images.

Kodak scientists were still listening when they developed several new platforms of color negative film, incorporating the latest advances in emulsion technology that were designed to give cinematographers more creative flexibility.

Several years ago, James Glennon, ASC, was reminiscing about a conversation that he had with Jack Warner. Glennon was a mail boy at the studio when he decided to pursue a dream of becoming a cinematographer. Glennon reported that when he asked the mogul for advice about the future, Warner replied, "If you want to know what the future will bring don't ask a scientist, because they will tell what they see at the end of a microscope. Ask an artist, because they use their instincts. We are an art gallery. Don't ever forget that."

The future: The dream goes on.

“We had to convince the National Film Board (NFB) of Canada that the (documentary) story (Letters from Karelia) required images captured on film. The archival superiority of film was also a factor. ... I calculated how much more it would cost to shoot on film, and then showed them where we could save the same amount in postproduction.”

—*Kelly Saxberg, Director - Editor*

THE NATURE OF LIGHT AND COLOR

THE PHYSICS OF LIGHT

Electromagnetic radiation travels through space as electric energy and magnetic energy. At times the energy acts like a wave and at other times it acts like a particle, called a photon. As a wave, we can describe the energy by its wavelength, which is the distance from the crest of one wave to the crest of the next wave. The wavelength of electromagnetic radiation can range from miles (radio waves) to inches (microwaves in a microwave oven) to millionths of an inch (the light we see) to billionths of an inch (x-rays).

The wavelength of light is more commonly stated in nanometers (nm). One nanometer is one billionth of a meter. Visible light has wavelengths of roughly 400 nm to roughly 700 nm. This range of wavelengths is called the visible spectrum.

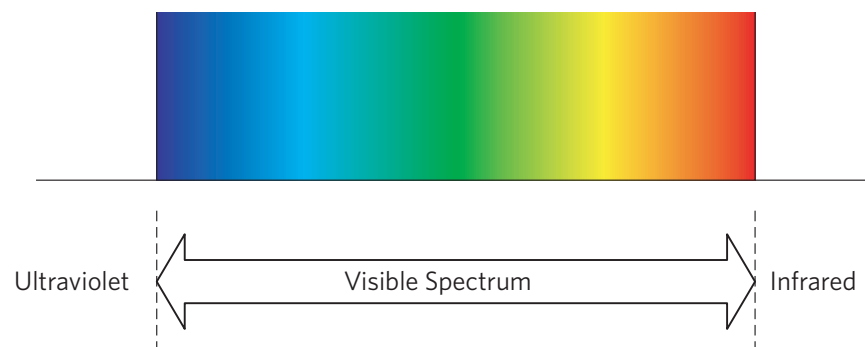

Electromagnetic radiation in the visible spectrum is typically generated by one of these sources:

- Incandescent sources. The most common incandescent source is a tungsten light.
- Non-incandescent sources such as fluorescent, metal halide, mercury vapor, neon, and HMI lights.
- The sun. (The sun is actually an incandescent source, since it produces light by incandescence. However, in the photographic community, incandescent refers to artificial sources.)

All objects emit some electromagnetic radiation. As an object is heated, it emits relatively more of the shorter wavelengths of electromagnetic radiation and relatively less of the longer wavelengths. It is this property of light that allows a light meter to measure light's color temperature. The following figure demonstrates the visible wavelengths of the relative energy emitted at each wavelength of various color temperatures and in 5500K Daylight. At 3200K there is a relatively large amount of the long wavelengths and a relatively small amount of the short wavelengths. As the color temperature increases to 5500K, 6500K, and 10000K, the relative amount of the long wavelength energy decreases and the relative amount of the short wavelength energy increases.

The 5500K Daylight curve is not as smooth as the 5500K curve because daylight is a combination of the energy emitted by the sun, energy absorbed by the earth's atmosphere, and energy scattered by particles in the earth's atmosphere.

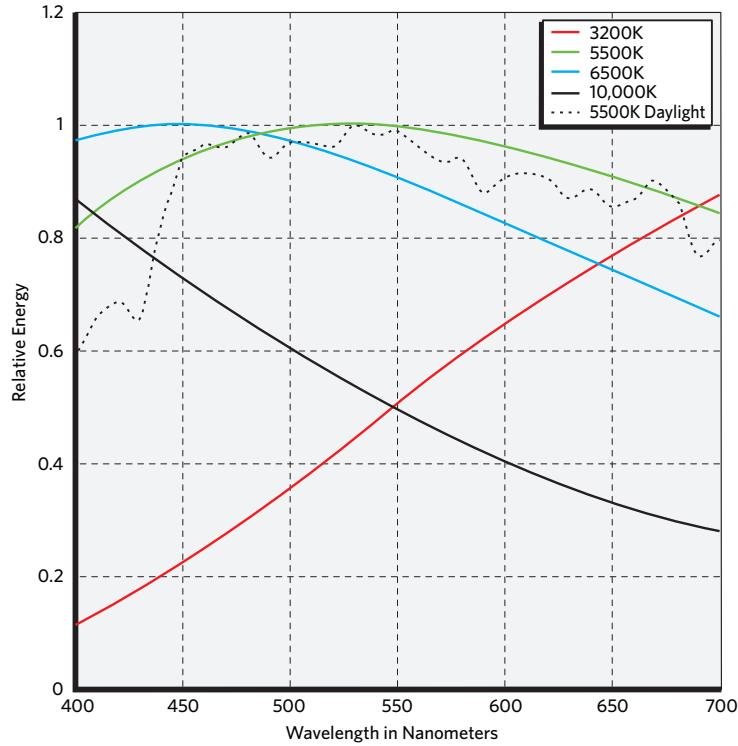

Relative spectral energy curves for different color temperatures.

When the electrons in a molecule or a gas are excited, they rise to a higher energy level within that atom or molecule. After a period of time, the electrons return to their normal energy level and emit the difference in energy as electromagnetic radiation. The energy emitted is frequently in the visible spectrum. The figure below shows the HMI and Xenon lamp spectral curves compared to the 5500K Daylight curve.

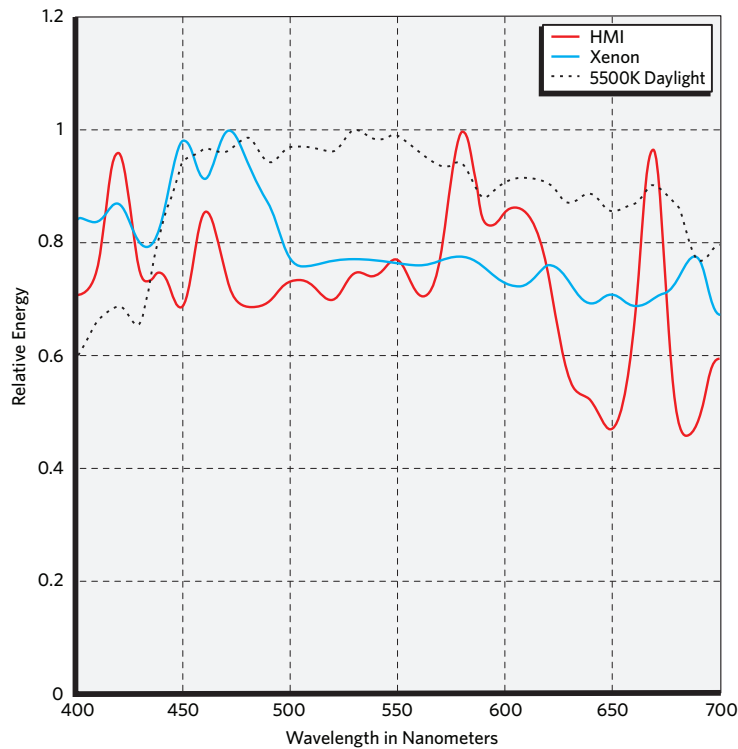

Relative spectral energy curves for the HMI and Xenon lamps compared to the 5500K Daylight curve.

When light strikes an object, the light can be transmitted, absorbed, or reflected. In many cases, all three occur. Transmission, absorption, or reflection can be determined by the wavelength of the light. For example, a piece of clear glass will transmit all the wavelengths of light striking the surface of the glass. If the glass is colored, some wavelengths are absorbed and some wavelengths are transmitted. If there are small particles in the glass, some of the wavelengths may be absorbed, some transmitted, and all reflected. In this case we would describe the glass as both colored and opaque. A piece of colored paper reflects some wavelengths, absorbs some wavelengths, and transmits no light.

If light strikes the surface of a transmitting object at an angle other than straight on, the light will be bent as it enters and exits the object. This property of light allows a lens to focus the light rays on a surface, such as the surface of the film used to photograph an object. Additionally, the short wavelengths are bent more than the long wavelengths. It is this property of light that produces a rainbow. As the light enters a water droplet, the light is bent. The light then reflects off the back of the water droplet. Then, as the light exits from the water droplet, the light rays bend again. Because the short wavelengths are bent more than the long wavelengths, the wavelengths of light are spread across the sky and we see the rainbow.

COLOR VISION

Vision starts when light from a scene enters your eye. The lens in your eye focuses the light as an image onto your retina. The human retina uses two types of cells to sense the light: rods and cones. These microscopic sensors are distributed across the retina, and each type serves a very different purpose. The rods and cones convert light into minute electrical impulses, which travel along nerve fibers to the brain. At the brain, they're translated into an impression of the shape and color of the observed object.

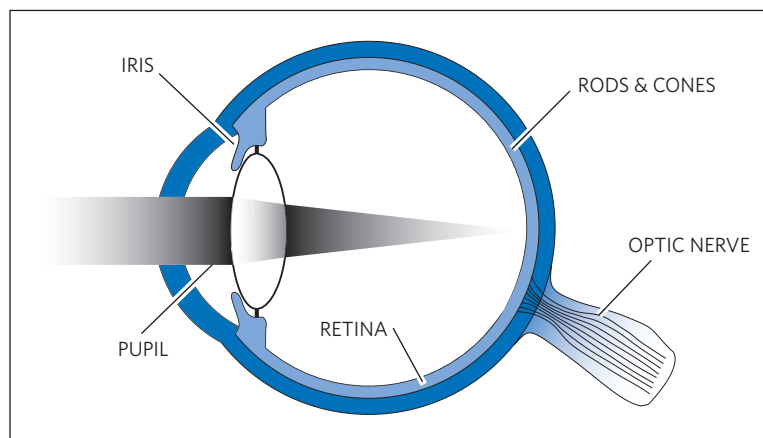

All rods have the same sensitivity to the wavelengths of light and, therefore, cannot see the color of an object. Rods see all objects as shades of gray. Because the rods are also very sensitive to light—much more sensitive to light than cones—they enable us to see in very low light levels, such as a night scene illuminated only by the stars or the moon. In bright scenes the rods are flooded with light and they cease to produce the signal that the brain uses for vision. In high brightness scenes only the cones provide useful information to the brain.

There are three types of cones: one has the greatest sensitivity to the long wavelengths of visible light; one has the greatest sensitivity to the middle wavelengths of visible light; and one has the greatest sensitivity to the short wavelengths of visible light.

We perceive brightness based on the total level of the signal coming from all the cones. We perceive color based on the relative signal levels coming from the three types of cones. When the cones sensitive to the long wavelengths are predominantly stimulated, we see red; when the cones sensitive to the middle wavelengths are predominantly stimulated, we see green; and when the cones sensitive to the short wavelengths are predominantly stimulated, we see blue. Because there are only three types of cones, all vision is based on these three color perceptions. Therefore, most colors are described as light or dark and a combination of two colors, for

example, red and blue (a reddish-blue or a bluish-red). Because of the processing of the signals from the cones in the brain, we cannot see a greenish-red or a reddish-green. The combination of red and green gives the sensation of yellow. Therefore, the object appears as greenish-yellow or yellowish-green. These sensations are the result of different amounts of signals from the red and green sensitive cones. When those signals are exactly the same, we see yellow with no red and no green.

The figure below shows the sensitivity of the rods and the three types of cones to the wavelengths of visible light.

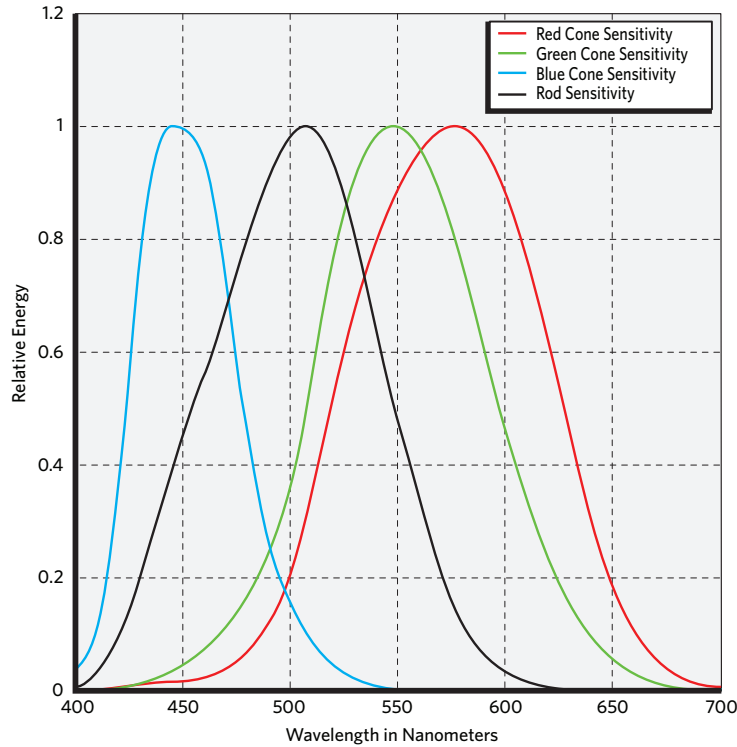

Spectral sensitivities of the human rods and red, green, and blue sensitive cones

Film spectral sensitivities are similar to the sensitivities of the cones. The following figure compares the cone and film spectral sensitivities. There are a number of reasons for the differences in the film and cone spectral sensitivities. The large overlap of the red and green cone sensitivities requires a considerable amount of image processing in the brain in order to produce the sensations of redness and greenness. Film is not capable of that much image processing. Scanned film could be processed much as the brain processes the cone signals, but the image processing increases the graininess, or noise, in the resulting image. Also, because images are typically viewed in lower lighting conditions than those present during photography, the color must be boosted in order for the projected motion picture images to appear natural. By shifting the spectral sensitivities in the film, it is easier to chemically or digitally boost the color in the resulting film image.

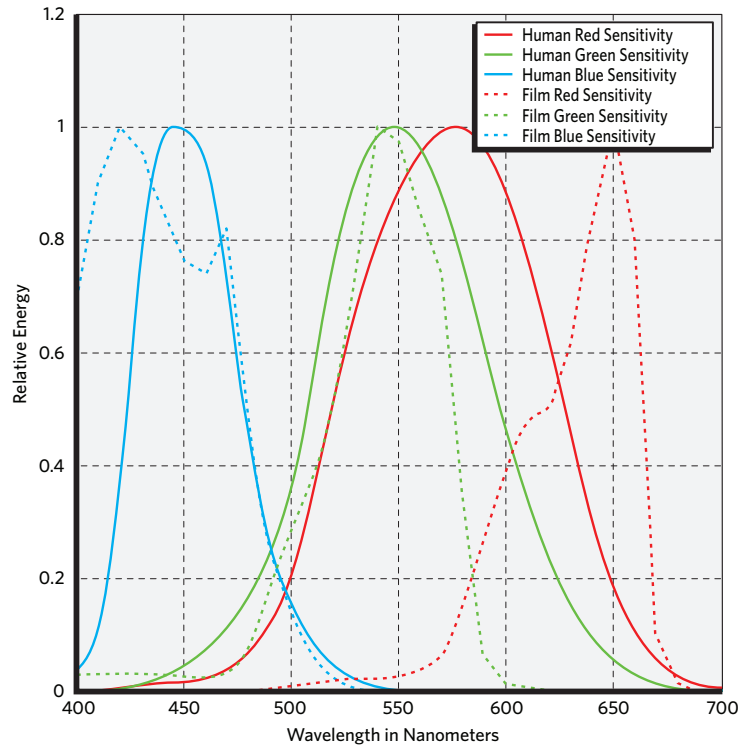

Spectral sensitivities of the human cones and red, green, and blue sensitive layers of color film.

THE REPRODUCTION OF COLOR

There are two basic systems of producing color: the additive color system and the subtractive color system.

Additive Colors

The additive color system reproduces colors by adding colored lights—its primary colors are red, green, and blue (RGB). If none of these colors are present, black results. If all the colors appear at their maximum intensities, the color produced is white. All the colors that can be produced by a three-color additive system are combinations of these three primary colors. When mixed together in various proportions, the additive color primaries of red, green, and blue give us the range of colors that we see. Two common additive systems are a television and a digital projector.

In the areas where two primary colors overlap, a secondary color appears. When overlapped, green and blue create cyan. Blue and red produce magenta. Red and green produce yellow.

When added in equal proportions, red, green, and blue result in white light. The absence of all three colors results in black. Mixing varying proportions or intensities of two or three additive primaries creates intermediate colors.

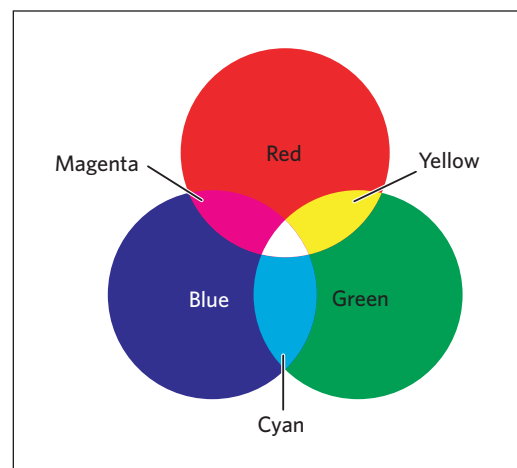

Subtractive Colors

The subtractive color system reproduces colors by subtracting some wavelengths of light from white. The three subtractive color primaries are cyan, magenta, and yellow (CMY). If none of these colors is present, the color produced is white because nothing has been subtracted from the white light. If all the colors are present at their maximum amounts, the color produced is black because all of the light has been subtracted from the white light. All the colors that can be produced by a three-color subtractive system are combinations of these three primary colors.

The subtractive system is associated with systems that depend on chemicals for their color, such as ink or dyes on paper and dyes on a clear film base (slide films, negative films, and motion picture print films). The colors that we do see in the subtractive system are the result of the wavelengths that are reflected or transmitted—not absorbed. The cyan absorbs red and reflects or transmits green and blue, the magenta absorbs green and reflects or transmits red and blue, and the yellow absorbs blue and reflects or transmits red and green.

The complimentary colors are the colors that are absorbed by the subtractive primaries. Cyan's complement is red; magenta's complement is green; and yellow's complement is blue. It is the light that is reflected or transmitted that we see. So a combination of a magenta and a yellow filter looks red because magenta absorbs the green and yellow absorbs the blue. Only the red is left, which we see.

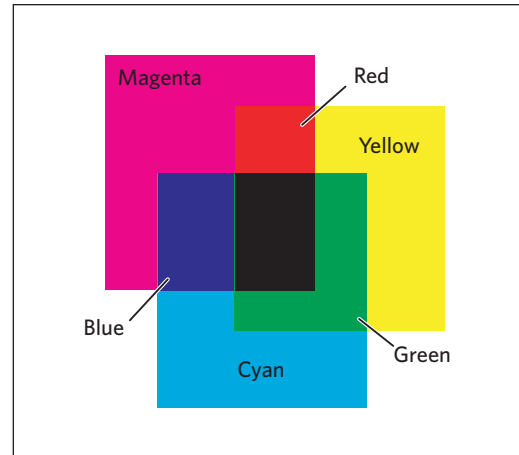

The Color Wheel

On a color wheel, complimentary colors are placed opposite one another. By combining these complimentary colors in varying degrees, you can create an infinite number of intermediate hues.

Red's complement is cyan. To render an image less red, you can add more cyan. To make an image more red, you can subtract cyan (or add more red).

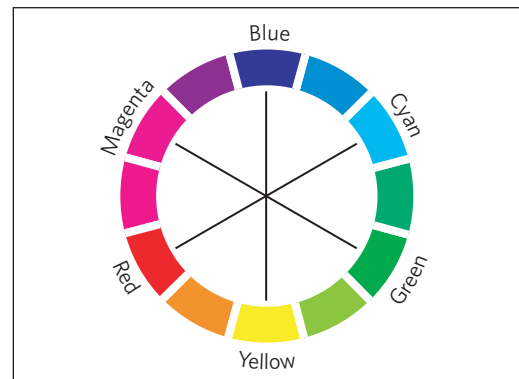

LIGHT SOURCES AND COLOR

Objects that transmit light, such as stained glass or projected motion picture film, let certain wavelengths pass while absorbing others. The wavelengths that pass through are the ones that you see; they determine the color of the object. For example, a piece of green glass (or a green filter) absorbs most light from the blue and red ends of the spectrum while transmitting green wavelengths.

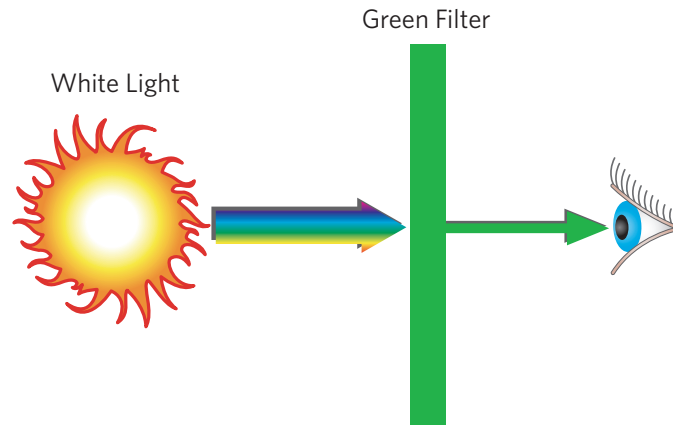

A magenta source yields different results. Through a green filter, most of the magenta light is absorbed and the filter appears black. An object's color rendition is the product of its actual color and the available light source.

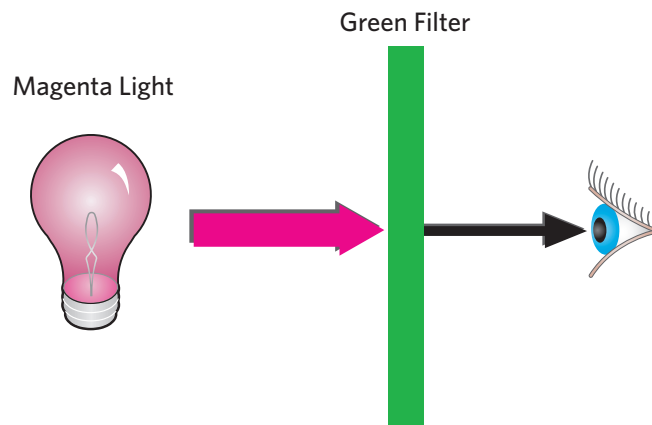

By adjusting a filter's intensity, we control the amount of light passing through it. An intense green filter absorbs practically all magenta light. As intensity diminishes, more magenta light passes through. Filtration is used to control the color of light during exposure and projection of film.

COLOR TEMPERATURE

Color temperature, expressed in degrees Kelvin, can be measured with a color temperature meter. To compensate for different color temperatures, film is color-balanced during manufacture. When exposed in tungsten light or daylight, respective films reproduce color correctly.

Daylight film is used when the primary source of illumination is skylight, daylight or HMI light, which approximates daylight. Tungsten film is used to capture scenes in which the primary light source is tungsten. Because daylight has a relatively flat spectral curve, which means roughly equal energy at all wavelengths, the red, green, and blue sensitivities of a daylight film are roughly equal. Because tungsten light's spectral curve

shows that much more red energy is emitted than blue light, tungsten film is balanced so that the blue sensitivity is correspondingly higher than the red sensitivity.

Filters can be placed over a camera lens or light source to adjust the color balance of light reaching the film. Thus, films can be used in light sources other than those for which they were intended. Each filter has predetermined transmission characteristics that pass certain wavelengths and block others. Film data sheets specify starting filter recommendations for most common light sources. An on-site test should be performed to verify results.

Color balance is more critical in color reversal films. Filters are used to make even small shifts in color. Color negative films are made into positive prints or transferred to a variety of electronic outputs. Adjustments, therefore, can be made during the printing phase or by a colorist in a postproduction facility.

The brain can adjust the level of the signal coming from the cones based on the intensity of the light falling on the cones. When the intensity is low, the brain increases the signal level; when the intensity is high, the brain decreases the signal level. In this way a white object appears white in daylight and in tungsten light. The brain continuously adjusts the color balance of each scene so that it appears correct even in varying light.

Limits to Color Temperature Measurement

Color temperature (Kelvin) refers only to the visual appearance of a light source—not its photographic effect. For example, some light sources emit strongly in the ultraviolet region of the spectrum; the color temperature of such a source does not measure this portion of the emission because the eye is not sensitive to radiation below 400 nm. Since a film is usually sensitive to ultraviolet radiation, a scene can appear too blue unless the ultraviolet light is filtered out. Different light sources may have the same color temperature, but the photographic results obtained with each may be quite different.

Color temperature does not take into account the spectral distribution of a light source. Unless the light source has a continuous spectral distribution, its effective color temperature alone may not be reliable as a means of selecting a suitable correction filter. For example, fluorescent lamps do not have the continuous smooth spectral-distribution curve that is characteristic of a tungsten-filament source.

Correlated Color (CC) Temperature refers to non-incandescent sources such as fluorescent, metal halide, mercury vapor, neon, and HMI lights. A correlated color temperature rating approximates the nearest true incandescent source.

When using a color temperature meter, you may use a swatch book of color correction gels to determine the correct gel needed for your film stock balance.

In a green vs. magenta reading (using the CC mode), the color temperature meter may detect a large amount of green and display 30M. The meter has calculated that a strong magenta correction is needed. You may try a full minus green gel from a swatch book in front of the meter receptor, then take a new reading. This magenta gel will absorb the green spike present in certain types of non-incandescent sources, such as fluorescent and sodium vapor.

To determine a red vs. blue reading, use the color temperature mode. If the source reads 5500K, and you're trying to match a tungsten-balanced film, try placing an 85 gel in front of the receptor. Ideally, the meter will read 3200K. If the meter reading is slightly off, try mixing gels of varying density.

Color Temperature for Various Light Sources

Artificial Light	
Match Flame	1,700K
Candle Flame	1,850K
40-Watt Incandescent Tungsten Lamp	2,650K
75-Watt Incandescent Tungsten Lamp	2,820K
100-Watt Incandescent Tungsten Lamp	2,900K
3200 K Tungsten Lamp	3,200K
Photoflood and Reflector Flood Lamp	3,400K
Daylight Blue Photoflood Lamp	4,800K
Xenon Arc Lamp	6,420K
Daylight	
Sunlight: Sunrise or Sunset	2,000K
Sunlight: One Hour After Sunrise	3,500K
Sunlight: Early Morning	4,300K
Sunlight: Late Afternoon	4,300K
Average Summer Sunlight at Noon (Washington, DC)	5,400K
Direct Midsummer Sunlight	5,800K
Overcast Sky	6,000K
Average Summer Sunlight (plus blue skylight)	6,500K
Light Summer Shade	7,100K
Average Summer Shade	8,000K
Summer Skylight will vary from	9,500 to 30,000K

Note: Do not confuse sunlight with daylight. Sunlight is only the light of the sun. Daylight is a combination of sunlight plus skylight.

“Film has the depth to create the magic I was looking for. I wanted a full spectrum of colors to create the vivid world that represented Angelina’s [Looking for Angelina] imagination, and her immigrant history, which is often seen in black and white and sepia tones.”

—*Sergio Navarretta, Cinematographer*

FILM STRUCTURE

What is motion picture film? The American National Standards Institute (ANSI) describes it as “a thick flexible strip of plastic, complying with a dimensional standard as defined within, whose use is specific to the process of manufacturing a motion picture.” That definition leads to about a dozen pages of further definitions about various aspects of motion picture film. For our purposes, let’s take a look at how film is made, and how an image is formed on that film.

THE STRUCTURE OF FILM

Film is made up of layers, and it’s the combination of these layers that give each film its character. Motion picture film consists of a transparent support film base, a light-sensitive emulsion, and a number of layers coated on both sides. Some layers are different from those coated on still film and are designed to help motion picture film travel smoothly through the camera.

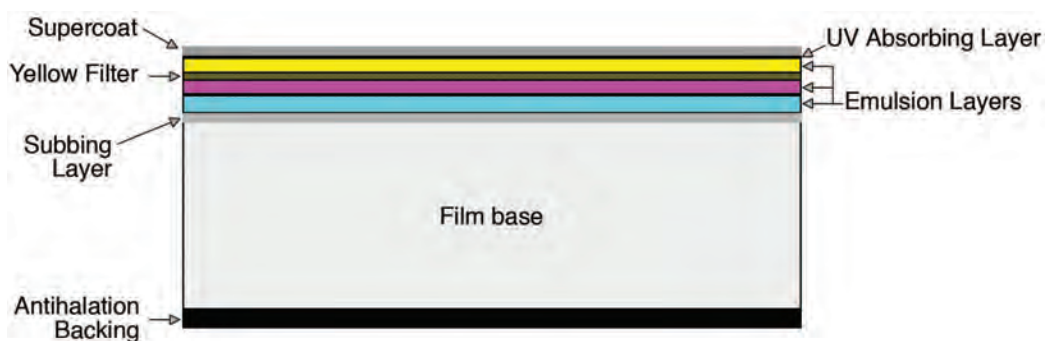

Film Base

The supporting layer in film is called the base. This base has to be transparent (with some optical density), free from imperfections, chemically stable, insensitive photographically, and resistant to moisture and processing chemicals, while remaining mechanically strong, resistant to tearing, flexible, and dimensionally stable.

Three plastics have been widely used as a motion picture film base:

- Cellulose nitrate was the first material used. Discontinued in the 1950s because it was highly flammable, cellulose nitrate is chemically unstable if stored in conditions that are too damp (it can decompose) or too hot (it can self-ignite).
- Cellulose acetates were developed to replace nitrate. Cellulose triacetate, called safety base, is much safer to use and store than nitrate. Most current KODAK and EASTMAN Motion Picture Films are coated on a cellulose triacetate base.
- Polyester base is used for all print films, most duplicating films, and some specialty films. Polyester is stronger and wears better than triacetate. Polyester’s storage life is up to ten times that of acetate. ESTAR Base, a polyethylene terephthalate polyester, is used for some KODAK and EASTMAN Motion Picture Films (usually intermediate and print films) because of its high strength, chemical stability, toughness, tear resistance, flexibility, and dimensional stability. The greater strength of ESTAR Base permits the manufacture of thinner films that require less storage room. ESTAR Base films and other polyester base films cannot be successfully spliced with readily available commercial film cements.

These films are spliced with a tape splicer or with a splicer that uses an ultrasonic or an inductive heating current to melt and fuse the film ends.

Emulsion

The most fundamental layer in a film is the emulsion layer(s), adhered to the base by means of a binder. The emulsion is the photographic part of the film, and as noted from ANSI, “consists of dispersions of light-sensitive materials in a colloidal medium, usually gelatin, carried as a thin layer(s) on a film base.” Emulsion is made by dissolving silver bullion in nitric acid to form silver-nitrate crystals. These crystals are dissolved and mixed with other chemicals to form silver-halide grains, and then suspended in the gelatin emulsion coating. The size and degree of light sensitivity of these grains determines the speed or amount of light required to register an image. The faster the film, the greater the apparent “graininess” of the image.

In 1991, The Motion Picture and Television Imaging division of Eastman Kodak Company received an OSCAR from the Academy of Motion Picture Arts and Sciences for incorporating KODAK T-GRAIN® Emulsion Technology into motion picture films. This term, now familiar among all types of film, describes flat silver crystals that capture more light without an increase in size.

In color films, three dye layers register various parts of the color, one on top of another, for the full color effect—in cyan, magenta, and yellow dyes. In fact, each color may have up to three layers (fast, medium, and slow) to capture the full range of scene brightness—from the deepest shadows to the brightest highlights—and to provide good exposure latitude. The three components also optimize the color, contrast, and tonal reproduction of film.

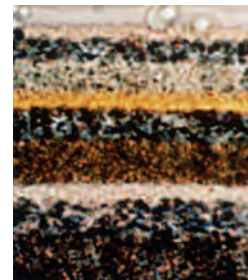

In each emulsion layer, color couplers are dispersed in tiny oil droplets around silver halide crystals. When the developing agent reaches the sensitized silver grain, oxidized developer is formed after donating electrons to the silver halide. The oxidized developer combines with the coupler molecule to form a colored dye. During subsequent processing steps, the silver is removed, leaving only colored dyeclouds where film grains used to be.

There are three types of color couplers, one for each of the color emulsion layers. Each color coupler forms a dye of one of the three subtractive primary colors and is located in a layer that is sensitive to light of its complementary color:

- A yellow-dye-forming coupler is located in the blue-sensitive emulsion layer
- A magenta-dye-forming coupler is located in the green-sensitive layer
- A cyan-dye-forming coupler is located in the red-sensitive layer



Subbing Layer

The subbing layer is applied to the film base so that the emulsion adheres to the base.

Ultraviolet Absorbing Layer

Although we can't see ultraviolet (UV) radiation, photosensitive silver halide crystals can be exposed by it. An ultraviolet absorbing layer is included to protect the imaging layers from exposure by UV radiation.

Supercoat

The top layer of the film is the supercoat. The purpose of this clear layer of hardened gelatin is to protect the emulsion from damage during transport through the camera.

Antihalation Backing

Finally, film may have what's called an anti-halation layer.

Light penetrating the emulsion of a film can reflect from the base-emulsion interface back into the emulsion, causing a secondary exposure around images of bright objects. This secondary image (halation) causes an undesirable reduction in the sharpness of the image and some light scattering. An antihalation layer, a dark coating on or in the film base, will absorb and minimize this reflection.

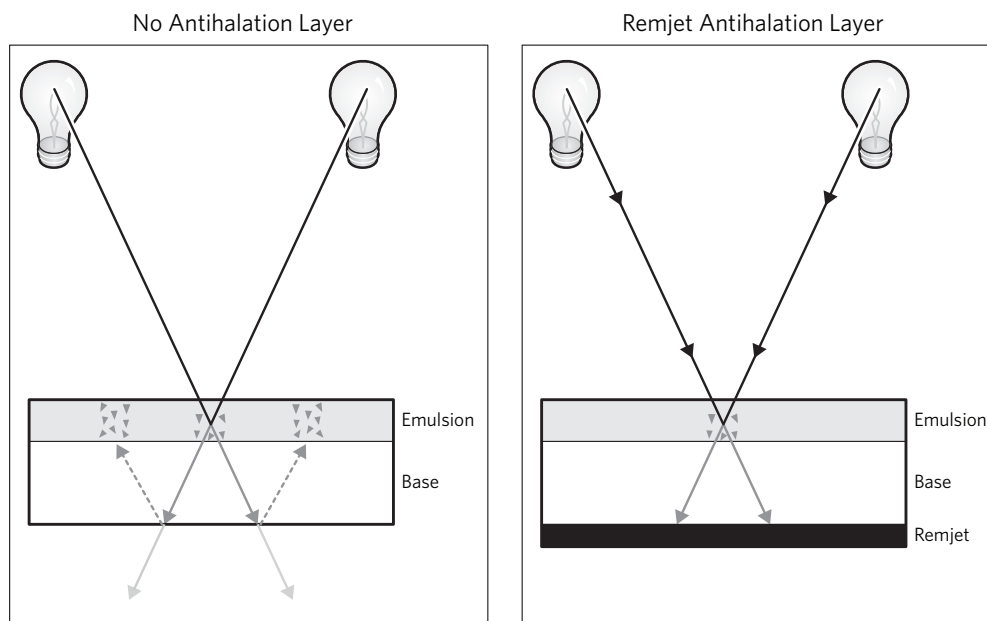

Three antihalation methods are commonly used:

- Remjet, a removable jet black layer, is the coating of carbon black particles in a water-soluble binder on the bottom of the film. It has four purposes: antihalation, antistatic, lubrication, and scratch protection. The remjet carbon layer is also conductive and prevents the build-up and discharge of static charges that can fog film. This is especially important in low relative humidity environments. Remjet also has lubricating properties. Like the supercoat on top of the emulsion, remjet resists scratching on the base side and helps transport the film through cameras, scanners, and printers.

Because remjet is black, it must be removed before the image can be seen. Remjet is removed during the first stage of processing, before the developer.

- Antihalation undercoating, a silver or dyed gelatin layer directly beneath the emulsion, is used on some thin emulsion films. Any color in this layer is removed during processing. This type of layer is particularly effective in preventing halation for high resolution emulsions. An antistatic and/or anticurl layer may be coated on the back of the film base when this type of antihalation layer is used.
- Dyed film base serves to reduce halation and prevent light piping. Film base, especially polyester, can transmit or pipe light that strikes the edge of the film and result in fog. A neutral-density dye is incorporated in some film bases to mitigate this effect. Dye density may vary from a barely detectable level to approximately 0.2. Higher levels are primarily used for halation protection in black-and-white negative films on cellulose bases. Unlike fog, the gray dye doesn't reduce the density range of an image; it adds the same density to all areas just as a neutral-density filter would. It has, therefore, a negligible effect on picture quality.

HOW IMAGES ARE FORMED ON FILM

The most vital components of film are the silver halide crystals. During camera or printer exposure to light, photons are absorbed by the silver halide crystals and form a "latent" or hidden image. The latent images are not visible to the human eye. They become visible during processing.

The latent image consists of a cluster of a minimum of four metallic silver atoms in the silver halide crystal structure. The presence of these silver atoms makes the whole crystal capable of being developed. Without them, the crystal will not develop.

Chemical development of the exposed crystals converts them to 100% silver, providing a huge amplification of the latent image.

In order to differentiate between tones of deep shadows all the way to bright highlights in the film image, various sizes of silver halide crystals are used. The smallest are the least sensitive and can only record the brightest highlights. The largest crystals are the most sensitive and can record the deepest shadows.

“The way I see it, we’re dealing with art. There’s a certain kind of sensation you want an audience to feel when they watch your movie. ... I see the choice of media more as an aesthetic and creative choice that eventually lends itself to certain economic aspects. I choose to invest in the look.”

—*Lemore Syvan, Independent Producer*

FILM TYPES AND FORMATS

A wide variety of camera films are available today, allowing filmmakers to convey exactly the look they envision. Image capture challenges, from routine through extreme, special effects, and unique processing and projection requirements can be resolved with today's sophisticated films.

TYPES OF MOTION PICTURE FILM

There are three major categories of motion picture films: camera, intermediate and laboratory, and print films. All are available as color or black-and-white films.

Camera Films

Negative and reversal camera films are used in motion picture cameras to capture the original image. Negative film, just as a still camera negative, produces the reverse of the colors and/or tones our eye sees in the scene and must be printed on another film stock or transferred for final viewing.

Reversal film gives a positive image directly on the original camera film. The original can be projected and viewed without going through a print process. Reversal film has a higher contrast than a camera negative film.

Color Balance

Color films are manufactured for use in a variety of light sources without additional filtration. Camera films are balanced for 5500K daylight or 3200K tungsten. Color films designated D are daylight-balanced. Color films designated T are tungsten-balanced.

Filtration over the camera lens or over the light source is used when filming in light sources different from the film's balance.

Intermediate and Laboratory Films

Labs and postproduction facilities use intermediate and print films to produce the intermediate stages needed for special effects and titling. Once the film has been edited, the cut negative may be transferred to print film. This is often done using intermediates to protect the valuable original footage from potential damage. Today, many feature films are post-produced digitally: the camera negative film is scanned to produce a Digital Intermediate; after digital editing and special effects work, a digital negative is produced on color intermediate film using a digital film recorder.

Print Films

Print film is used to print both the first work print (when work print is being used) and multiple copies of the final edited version.

FILM GAUGE

Gauge refers to the width of the film, and there are four commonly in use for camera films: Super 8, 16 mm, 35 mm, and 65 mm.

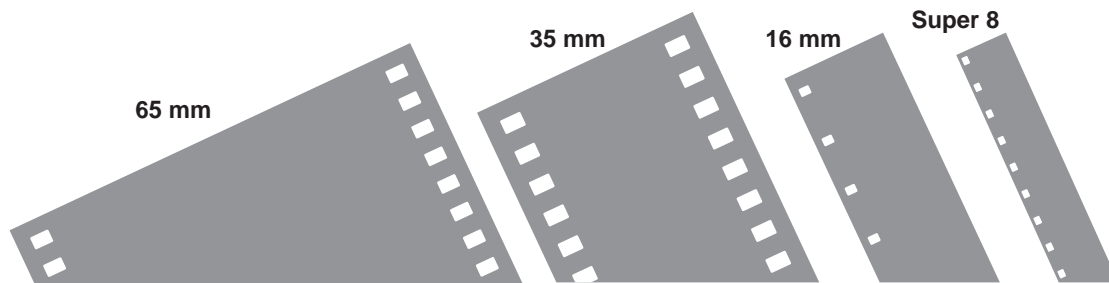

35 mm is most popular for feature films, commercials and US television. It can be printed to 35 mm print film or scanned or transferred on a telecine.

16 mm film is typically supplied in single perforated format except for use in high-speed cameras, which use double perforated film. The Super 16 format is typically used for low to medium budget feature films, where it can be blown-up to 35 mm release prints. It is also widely used for television production, where its aspect ratio fits 16:9 wide-screen format well.

Super 8 is available as both negative film or reversal film, supplied in self-contained cartridges.

The 65 mm format is used as a camera film gauge for making prints on 70 mm print film for widescreen presentation such as IMAX and OMNIMAX.

IMAGE FORMAT AND ASPECT RATIO

The film image format describes only the image aspect ratio (shape). 35 mm or 65 mm gauges can have several image formats, because aspect ratio is independent of gauge.

The aspect ratio is the relationship between the width and height of an image. An image that's twice as wide as it is high has an aspect ratio of 2:1.

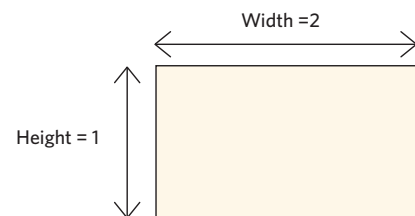

Rules for Aspect Ratios

- Aspect ratio = width divided by height
- Aspect ratios are independent of the film gauge (the width of the film)
- Aspect ratios are expressed two ways:
 - As a ratio with the height as unity, for example 1.78:1 (used for film)
 - As a simple ratio with the width and height as whole numbers, for example 16:9, or 16x9 (used for widescreen or HDTV)

The industry standard for 35 mm theatrical motion pictures remained a constant 1.37:1 between the introduction of sound and the introduction of CINEMASCOPE in 1953.



The full picture shows the 1.37:1 aspect ratio. The dotted lines show the border of the very similar 1.33:1 ratio.

1.33:1 is the standard TV/Video ratio (expressed as 4:3 in the TV industry). It was based on the 1.37:1 aspect ratio. These two ratios are so similar that they are sometimes used interchangeably. This is also the aspect ratio of regular 16 mm and Super 8.

In the United States, there are two aspect ratios commonly used for 35 mm film projection: 1.85:1 (flat) and 2.40:1 (scope). Theater owners who wanted to create a wide screen developed 1.85:1; they did this by cutting off the top and bottom of the 1.37:1 image.



1.85:1 (known as "Flat")

The 2.40:1 image was developed from the 2.35:1 CINEMASCOPE system. Special anamorphic camera lenses are used to squeeze the image during capture. A similar lens is used to expand or un-squeeze the image during projection. The original 2.35:1 image was later modified to 2.40:1.



2.40:1 ("Scope")

A common aspect ratio in Europe is 1.66:1, the native aspect ratio of Super 16. This is because many films shot in Europe were shot on Super 16 and then blown up to a 35 mm print. The 1.66:1 ratio is very similar to the current standard for HDTV, 1.78:1 or 16x9.



1.66:1



1.78:1

Two 70 mm formats are also in current use. 70 mm wide at 2.2:1 and IMAX, which is 1.43:1. Both are projected onto much larger screens than 35 mm formats.



70 mm widescreen



The IMAX format

SHOOTING FORMATS

4-perf

The most common shooting format is 4-perf 35 mm. Feature films with aspect ratios of 1.85:1 and television programs may use this format. The cinematographer frames for the final aspect ratio, and that part of the image is used for electronic transfer to video or projection in theaters.

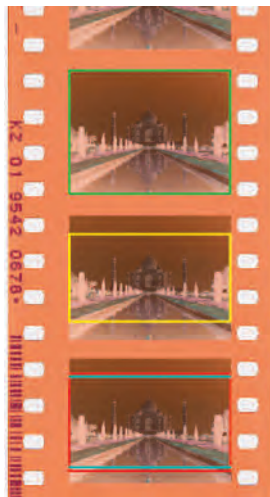

The boxes in this image show the different aspect ratios that can be extracted from the 4-perf frame. In green 1.37:1 (4x3), in yellow 1.85:1, in red 1.66:1, and in cyan 1.78:1 (16x9).

4-perf scope

With 4-perf scope the image is photographed through special lenses that squeeze the image. The image is then “unsqueezed” during projection.



A scope negative and print. The entire area will become the 2.40:1 image when unsqueezed.

4-perf Super 35

Super 35 uses the whole frame of film, including the space usually reserved for the soundtrack. From this full frame, a 2.40:1 extraction is made in the intermediate process, optically or digitally, to produce a squeezed negative for printing.

The boxes in the images below show the aspects that can be taken from a Super 35 mm frame:

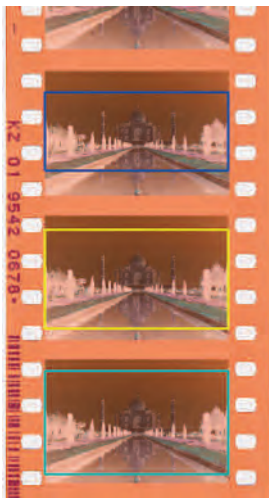

2.40:1 (the most common) is shown in blue, 1.85:1 in yellow, and 1.78:1 (16x9) in cyan.



This is what the squeezed print of the 2.40:1 would look like.



If shooting with a 1.85:1 aspect ratio, the image will also have to be resized to fit in a standard release format.

3-perf

The 3-perf format was originally developed for television. Advancing the negative 3 perfs at time instead of 4 eliminated the extra space between frames. That extra space had been helpful in splicing 35 mm negatives together, but such splicing is seldom used in television production. It was once impractical for feature films but digital intermediates have made this a viable format for feature films.

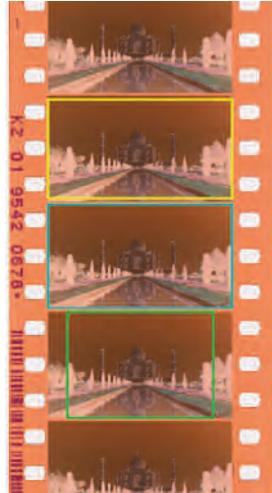

The boxes in this image show the aspect ratios that can be taken from 3-perf. In yellow 1.85:1, in cyan 1.78:1 (16x9), and in green 1.37:1 (4x3). Note that in the 1.37:1 frame, the lines are centered, but some camera systems may be centered on a different part of the frame.

2-perf

This format is similar to 3-perf, but the camera pulls down 2 perfs instead of 3.

2-perf is used to create a 2.40:1 image with a minimum amount of film. Like Super 35, the image must be digitally or optically enlarged to a 4-perf anamorphic intermediate/negative. This process was once called TECHNISCOPE.

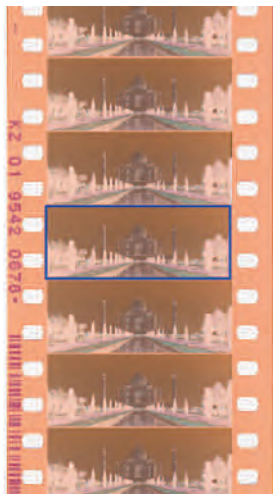

On the left, the 2.40:1 aspect ratio is outlined in blue. This image must be squeezed optically or digitally into a CINEMASCOPE frame (on right) just like Super 35 2.40:1.

VISTAVISION (8-Perf)

VISTAVISION is a 35 mm horizontal format with an eight-perforation pull down (across), which was typically used with high quality background plates in special effects work. The camera aperture is approximately 1.5:1 (37.7 x 25.2 mm).



The 2.40:1 frame is outlined in blue above but the VISTAVISION format is primarily used for special effects and not entire films.

Hard matte

A hard matte can be used in the camera or applied when printing optically or outputting digitally. It will mask the image area that is not being used.



Super 16

The image resulting from Super 16 is the same height as standard 16 mm, but the image extends into the perforation area. The native aspect ratio of Super 16 is 1.66:1, which is nearly identical to HDTV (1.78:1). When Super 16 is blown up to 35 mm, an aspect ratio of 1.85:1 is usually taken from it.

Super 16 is currently the most common shooting format for many independent films, television productions, advertising, music videos, and documentaries.



On the left is a 16 mm strip with the common aspect ratios outlined: 1.66:1 in red, 1.78:1 (16x9) in cyan, and 1.85:1 in yellow. In the center is an enlargement of the frames and to the right is a print of the blown up image.

Why Super 16?

Super 16 costs less than 35 mm origination, yet it maintains comparable quality and resolution overall. It's appropriate for a variety of distribution formats, including large screen releases.

For first-time features, films with a small budget, and films with a limited theatrical run, Super 16 can be ideal. Established filmmakers such as Mike Figgis (*Leaving Las Vegas*), Spike Lee (*Get On The Bus*), or Steve James and Peter Gilbert (*Prefontaine*) have found Super 16 to be a cost-effective solution.

Worldwide HDTV transmission standards have established a wide-screen aspect ratio of 16x9 (1.78:1). Originating on film in the 1.66:1 aspect of Super 16 is a means of future-proofing a production investment in order to guard against incompatibility and obsolescence.

Super 16 has been the format of choice for reasons ranging from the resulting Look, the cost-savings, the modest size of equipment packages, and any combination of these. Rugged film cameras are getting smaller and even more portable, as light as 4½ lb. (2.4 kg). They're proven in the toughest shooting environments and weather: in high humidity, burning sun, snow, dust, and sand.

16 mm

The Standard 16 mm image has the same aspect ratio as the original 35 mm academy format. It's typically used for 4:3 television origination. The image is symmetrical on the centerline, and the area to the right on single-perf print stock can be used for an optical soundtrack.

Almost all 16 mm cameras can be used with single-perf film. Double-perf stock is also available, but is typically used for shooting with specialized high-speed cameras. It can be used for normal sync shooting, but only in 1.37:1 format (not for Super 16).



Regular 16 mm image on single-perf 16 mm stock

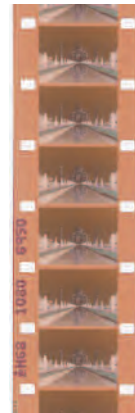

16 mm image on double-perf stock

Super 8

Once considered an amateur format, Super 8 is now used for effect in promos, documentaries, and many other applications. It is also used as an effective tool for teaching film. It is supplied in self-contained cartridges.



These are scans of Super 8 film. On the left is a negative and on the right is reversal.

65 mm

Images made on 65 mm film have a 2.2:1 aspect ratio. Release prints are made on 70 mm print film. This was once necessary to accommodate six magnetic sound tracks on the edges of the film. Today a double-system sound system is used with separate CDs having 6-track sound controlled by a time code printed on the film.

65 mm IMAX

IMAX and OMNIMAX productions use 65 and 70 mm film but with a horizontal image and a 15-perforation pull-down (across) for very large-screen shows.

CHOOSING A FILM STOCK

The choice of one stock over another largely determines the texture and mood of an image. The use of multiple film stocks can help to separate different looks within a film. Within the two main categories—daylight (D) and tungsten (T)—stocks are available in a variety of sensitivities and contrast characteristics.

Exposure Index	Color Balance	Recommended Filter for Daylight Use	ND Filter Suggestion	Suitability for...			
				Daylight Exterior	Daylight Interior / Window Light	Well-Lit Studio	Limited Light
50	D	None	None to 0.6	A	C	NR	NR
100	T	85	0.3 to 0.6	A-	D	A	C
200	T	85	0.6 to 0.9	A-	D	A	B
250	D	None	0.9	A	A	D with 80A filter	NR
500	T	85	0.9	B	B with 85 or 81EF	A	A

KEY:

A = Best Use

B = Good Use

C = Possible Use

D = Difficult Use

NR = Not Recommended

The choice of an appropriate stock is determined by a combination of aesthetic and practical considerations.

Low speed films have a tighter grain structure and produce less texture than faster films. Normally we shoot daylight films in exterior scenes where there is ample light. But it's possible to shoot the faster stocks in the same situation in order to incorporate their textural component.

Your scene might take place in a very low-light situation. There is a variety of high-speed films that offer a number of possibilities. You can manipulate slower film to work in the same situation, with even more "Look" options.

Low contrast films tend to see into shadow areas a bit more than the normal stocks. They also possess a softer, less saturated feel. These films are especially helpful in situations where the negative will be transferred or scanned, and the intent is to capture as much tone scale as possible.

Each film can be used in nearly any situation, albeit with significantly different outcomes. You control the vision and you create the "Look."

What Are Your Shooting Needs?

1. Where will your film end up? On film or other electronic or digital format?
2. Are you working with daylight or tungsten lighting?

3. Unpredictable shooting? Low light conditions?
4. Do you need medium speed with better image structure?
5. High color saturation?
6. Blue screen work?
7. Lower contrast, more open shadows, softer look?

Negative and Reversal Films

Negative film is available in a range of speeds and color balances, and it offers the latest emulsion technologies. Negative film has wide exposure latitude, is fine-grained and sharp, and processing is widely available. Negative film must be printed or scanned in order to result in a positive image.

Reversal film provides a positive image directly, with brilliant saturated colors. It is fine grained and sharp. Reversal film has very narrow exposure latitude.

Negative

- Range of speeds/balances/looks available
- Latest emulsion technology
- Wide exposure latitude
- Fine grained and sharp
- Processing widely available
- Printing/scanning necessary to view

Reversal

- Direct positive image
- Brilliant saturated colors
- Fine grained and sharp
- Narrow exposure latitude

Film Speed

The next choice when selecting your film stock is the exposure index (EI). The film's speed is a measure of its sensitivity to light.

Select an exposure index based on the amount of available light you will have. If you are shooting outside in bright daylight conditions you may wish to shoot an EI 50 stock. If you are shooting with available light or a minimum lighting package, EI 500 would be appropriate.

A word about film speeds

You probably know that motion picture films use exposure index (EI) to indicate speed. Although similar, EI is not the same as the ASA or ISO speed used for still films. EI denotes a somewhat conservative figure related to the higher quality requirements of motion picture film that must be projected onto a large screen. Typically the EI speed is about one stop lower than ASA or ISO. EI 500 film, therefore, is the equivalent of ASA/ISO 1000.

Color Balance

The scenes we see and photograph are illuminated by a variety of different colored light sources. Because the human eye adapts to different colors of light, the scenes all appear neutral—a sort of automatic white balance.

Conversely, film has fixed color sensitivities and does not adapt; different colors of illuminant are reproduced as different color balances.

Films are designed for exposure under tungsten lights or in daylight. Filters can be used on the camera lens to convert these sources or to provide correction—such as for other sources like fluorescent. A tungsten-balanced film can be shot in daylight using a WRATTEN 85 Filter with a speed loss of only 2/3 stop. However, when shooting a daylight-balanced film under tungsten illumination, the speed loss is greater: 2 stops. Additional correction can be applied by the color timer in the lab or the telecine.

“The director wanted to shoot some football scenes (for the Telefilm Brian’s Song) in Super 8 mm. I think he was expecting a negative reaction (from me), but I liked the idea because I knew we had a tight schedule and Super 8 mm would allow us to shoot those scenes with radically different textures and psychological impact.”

—James Chressanthis, ASC, Cinematographer

BASIC SENSITOMETRY AND CHARACTERISTICS OF FILM

BASIC PHOTOGRAPHIC SENSITOMETRY

Sensitometry is the science behind the art of filmmaking. It is the measurement of a film's characteristics. These measurements are expressed in numeric and chart form to convey how a film will react to the amount of light, the type of lighting, the amount of exposure, the type of developer, the amount of development, and how all these factors interact. In most cases, a cinematographer doesn't need a great depth of technical information to use motion picture films—using the right film speed and the right process will suffice. On the other hand, having a basic understanding of film sensitometry will help you in tasks as simple as film selection to as complicated as communicating the mood of a challenging scene.

THE CHARACTERISTIC CURVE

At the heart of sensitometry is the characteristic curve. The characteristic curve plots the amount of exposure against the density achieved by that exposure:

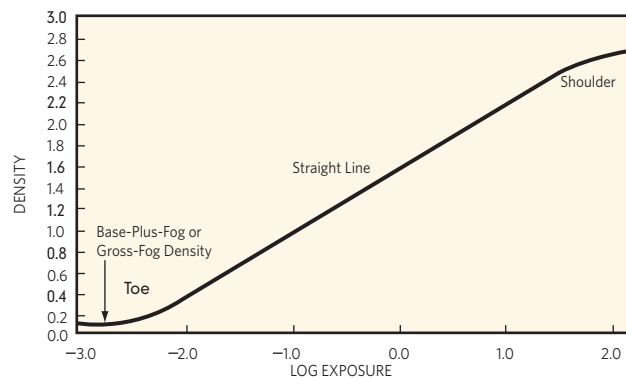

To create a characteristic curve, we first need some densities to plot, and they come from a sensitometric tablet exposed onto the film. Commonly called a step tablet, this highly calibrated tool consists of 21 equally spaced intervals of grey. When film is exposed through the step tablet, the resulting densities (darkness) of the 21 steps are measured on a densitometer. Density is placed on the vertical axis.

Exposure is placed on the horizontal axis. On a characteristic curve, the exposure numbers are converted to logarithmic values. One reason is to compress the amount of data into a usable space. Another is so that the curve shape looks like even steps.

The curve itself consists of three parts: toe, straight-line portion, and shoulder.

The dark portions (shadows) of a scene are the light (clear) parts of the negative. (The opposite would be true when looking at a characteristic curve of a reversal film.) These dark portions are represented as the toe part of the curve. We say the shadows “fall” on the toe.

The light portions of a scene (white shirts, lights, bright reflections), called highlights, are the dark parts of the negative. These light portions are represented as the shoulder part of the curve. We say the highlights “fall” on the shoulder.

The intermediate areas of a scene are called midtones; they "fall" on the straight line part of the curve.

Characteristic curves take on an "S" shape for two reasons. One is that the arithmetic data has been compressed into logs. The other is that film does not reproduce extremely dark and/or extremely light areas in the same way as midtones. A film's ability to record detail in extremely dark subjects is called "shadow detail," and is reflected in the toe of the curve. Likewise, a film's ability to record detail in bright subjects is called "highlight detail" and is reflected in the shoulder of the curve.

What Can Be Learned From a Characteristic Curve?

There are many things we can learn from the characteristic curve, including lowest density, highest density, gamma, contrast index, and photographic speed of the film. A characteristic curve is like a film's fingerprint.

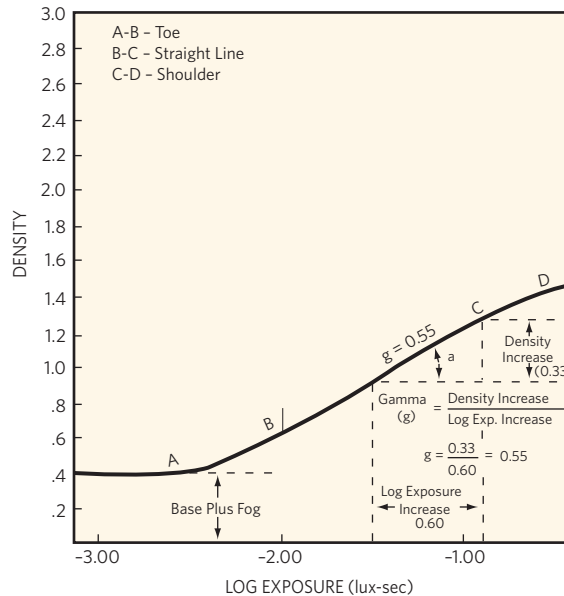

D-min

Lowest density is more often called D-min (density-minimum). It is a result of the transparent base and a slight chemical fogging of the film emulsion. Chemical fog occurs because a few silver halide crystals will spontaneously develop, even though they received no exposure. Because of this fogging, D-min is sometimes referred to as base plus fog, and sometimes as gross fog. In color films it is called base plus stain.

D-max

D-max (density maximum) refers to a film's highest density, and measures the maximum darkness a film can achieve. Most black-and-white films' characteristic curves don't show the film's D-max; it's often beyond the scale printed from the step tablet. During normal use, films aren't typically exposed to D-max.

Speed Point

The speed assigned to any given film is derived from the exposure required to produce a certain minimum density. This "speed point" is generally 0.1 above base plus fog. There is no scientific basis for this value. Rather, it is the point at which the human perceives a noticeable increase in density.

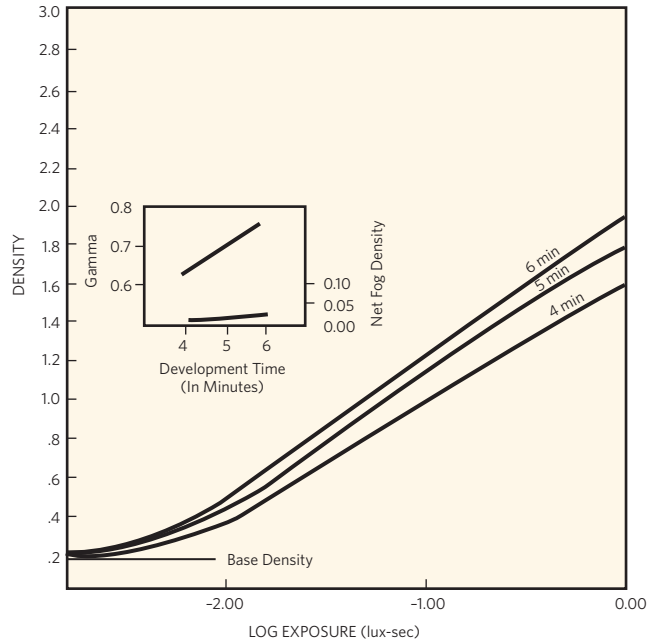

Notice that the longer the development time, the steeper the slope of the curve. Most of the change is in the straight line and shoulder of the curve, and the toe remains nearly constant. Notice that all of the data that affects contrast is written on the graph.

EXPOSURE INDEX AND LATITUDE

Proper exposure depends on four variables: the length (time) of exposure, the lens opening, the average scene luminance, and the speed (Exposure Index) of the film.

Exposure Index

The film exposure index (EI) is a measurement of film speed that can be used with an exposure meter to determine the aperture needed for specific lighting conditions. EI is derived from the “speed point” on the characteristic curve—a point that corresponds to the exposure required to produce a specific optical density. The indices for KODAK Motion Picture Films are based on practical picture tests and make allowance for some normal variations in equipment and film that will be used for the production.

To keep film speed values simple, only certain numbers from the entire range are used, and speed points are rounded to the closest standard number. Below is part of the table of standard film-speed numbers:

32	64	125	250	500
40	80	160	320	650
50	100	200	400	800

Bold numbers show film speeds used on current KODAK Films.

In photography, the exposure system is based on the number 2. When we halve or double the camera settings, we make a one stop change in exposure. Thus films speeds 100 and 200 are one stop apart.

Standard film speed values are 1/3 stop apart. This is because the log of 2 is roughly 0.3 (the density change achieved by halving or doubling exposure). One-third stop increments result in a 0.1 log E change, which happens to be a convenient interval to work with.

Reciprocity

Reciprocity is the relationship between light intensity (illuminance) and exposure time, in the context of total exposure a film receives. According to the Reciprocity Law, the amount of exposure (H) received by the film equals the illuminance (E) of the light striking the film multiplied by the exposure time (T):

$$E \times T = H$$

A film attains maximum sensitivity at a particular exposure (normal exposure at the film's rated exposure index). This sensitivity varies with the exposure time and illumination level. The variation is the "reciprocity effect." Film produces a good image within a reasonable range of illumination levels and exposure times. However, at extremely low illumination levels, the calculated increase in exposure may not produce adequate exposure. When this happens, the reciprocity law has failed. This condition is called "Reciprocity Law Failure" because the reciprocity law fails to describe the film sensitivity at very fast and very slow exposures.

The Reciprocity Law is usually effective for exposure times of 1/5 second to 1/1000 second for black-and-white films. Above and below these speeds, black-and-white films are subject to reciprocity failure, but their wide exposure latitude usually compensates for the effective loss in speed. Underexposure and a change in contrast result from Reciprocity Law Failure. The photographer must compensate for color film speed loss and color balance changes because the speed change may be different for each of the three emulsion layers. Contrast changes, however, cannot be compensated for, and contrast mismatches can occur.

Exposure Latitude

Latitude in exposure is the permissible change in camera exposure that can be made without a significant effect on image quality. We can determine latitude from the characteristic curve.

If the range of brightness (difference between the darkest and lightest objects in the scene) as recorded on film is 60:1, then the brightness range, expressed as a log, is 1.8. A typical characteristic curve covers a log E range of 3.0. A range of 1.8 can fit inside that range easily with some room (latitude) to spare. A normal exposure would be placed at the speed point.

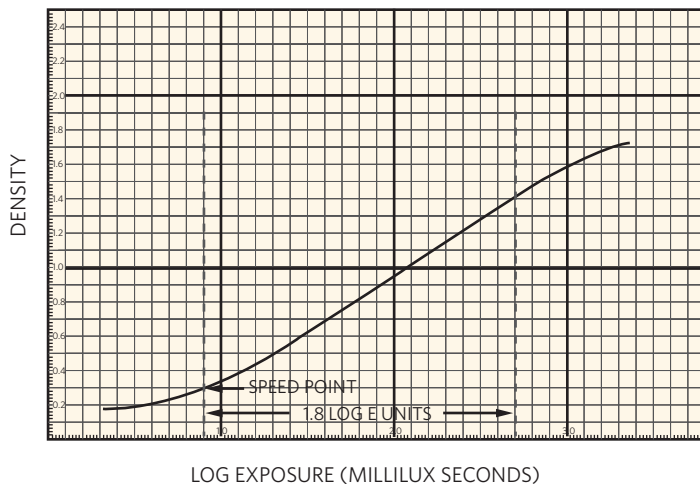

Moving in steps of 0.3 log E units, (one stop), we see that we can move the brightness range left two times before running off the curve.

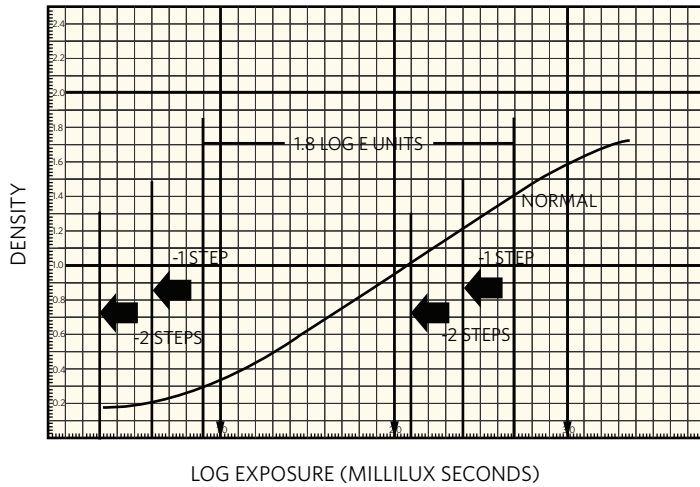

Similarly, we can move right two times before running off the curve.

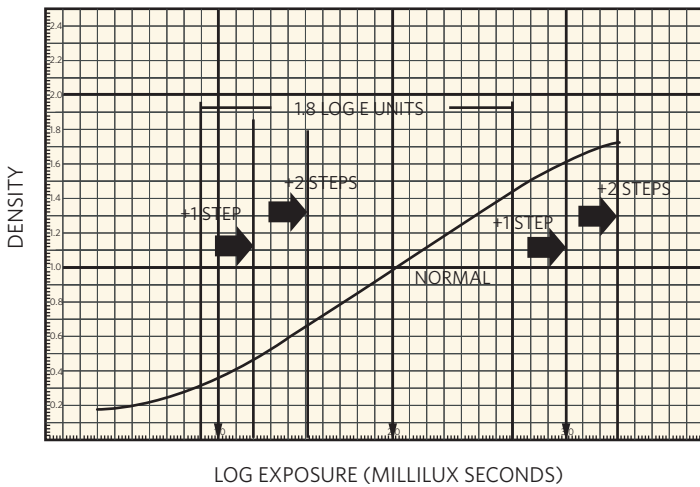

In this particular case, our underexposure latitude is two stops and our overexposure latitude is two stops.

GRAININESS AND GRANULARITY

The terms graininess and granularity are often confused. They refer to distinctly different ways of evaluating image structure. When a photographic image is viewed with sufficient magnification, the viewer experiences the visual sensation of **graininess**, a subjective impression of a random dot-like pattern. This pattern can also be measured objectively with a microdensitometer. This objective evaluation measures film **granularity**.

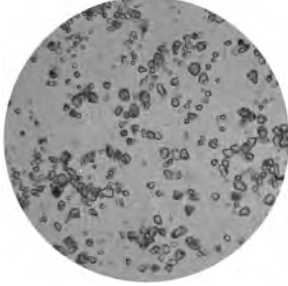
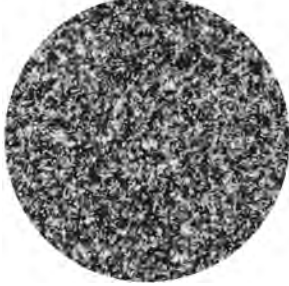
	
<p>Grains of silver halide are randomly distributed in the emulsion when it is made. This photomicrograph of a raw emulsion shows silver halide crystals.</p>	<p>Silver is developed or clouds of dye formed at the sites occupied by the exposed silver halide. Contrary to widely held opinion, there is little migration or physical joining of individual grains. Compare the distribution of silver particles in this photomicrograph with the undeveloped silver halide in the unexposed film at left.</p>

Speed of the film is relative to grain surface area (in sensitized films)—the fastest or most sensitive grains are also the largest grains. Graininess is more obvious in shadow areas and underexposed areas because the fastest, largest grains are predominantly exposed. Camera films are the fastest type of motion picture film; laboratory films, used in more controlled settings are substantially slower and less grainy.

The visual sensation of grain in projected motion picture images is different than in still photographs. Film images are captured on a mosaic of randomly distributed silver halide grains. Those grains then form an image of tiny dye clouds. If the image has fine detail, you'll have difficulty finding the detail in any single frame. Show 24 frames per second and the cumulative effect of the detail caught on each frame is delivered to the eye. When these images are processed in the brain, an incredible amount of detail is perceived.

Diffuse rms Granularity

Microscopic examination of a black-and-white photographic image reveals particles of metallic silver suspended in gelatin. The subjective sensation of this granular pattern is called graininess. The measurement of the density variations is called granularity. (In color films, the sensation of graininess is the result of dye formation where silver halide particles existed in the unprocessed film.)

Granularity measurement begins with density readings from a microdensitometer (a densitometer with a very small aperture, usually a 48-micron diameter) at a net diffuse density of 1.00 above base density. The small aperture measures fluctuations in density, and the standard deviation from average is called root-mean-square (rms) granularity and is expressed in terms of diffuse granularity. Since standard deviation numbers are very small, they are multiplied by 1000, which yields a small whole number, typically between 5 and 50. Diffuse rms granularity numbers are used to classify graininess. The graininess classifications are:

Diffuse rms Granularity Value	Granularity Classification
45, 50, 55	Very coarse
33, 36, 39, 42	Coarse
26, 28, 30	Moderately coarse
21, 22, 24	Medium
16, 17, 18, 19, 20	Fine
11, 12, 13, 14, 15	Very fine
6, 7, 8, 9, 10	Extremely fine
Less than 5, 5	Micro fine

SHARPNESS AND MODULATION-TRANSFER CURVE

The “sharpness” of a film is the subjective perception of good edge distinction between details in a photograph. However, the boundary between dark and light details is not a perfectly sharp line. The dark areas in a negative tend to bleed over into the light areas because of light scattering (or diffusion) within the emulsion. This effect varies with different types of emulsions, the thickness of the film base, overprocessing, as well as the anti-halation properties of the base and its backing. These factors all affect our perception of a good edge.

The objective measure of a film’s sharpness is expressed as an MTF curve (for Modulation Transfer Function). Basically, MTF shows the loss of contrast caused primarily by light scattering within the emulsion during exposure. The curve represents the contrast between light and dark areas relative to the original light and dark areas on a test target. A perfect reproduction would result in a horizontal line at 100%, even as the space between the light and dark areas decreases (represented by a movement from left to right on the horizontal axis). In reality, as the space between the light and dark areas decreases, the film’s ability to make the distinction between light and dark fails, and the percentage drops accordingly.

In the example below, film A provides sharper results when the distance between light and dark areas is higher, but decreases more rapidly than film B.

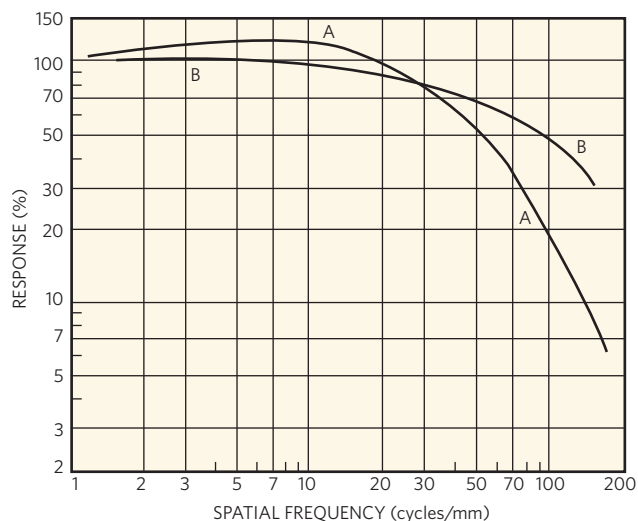

Note that in some cases, an MTF curve actually shows a response greater than 100%. The most common cause for this is “developer adjacency effect,” where fresh developer washes over onto dark areas, and exhausted developer washes from dark areas (where it was working hard) to lighter areas.

MTF curves should be used carefully, keeping in mind that additional factors influence the sharpness of a finished film, including camera movement, lens quality, and scene contrast. All other factors being equal, the comparison of one film’s MTF to another’s is a very useful tool.

NOTE: The modulation transfer function values published by Kodak are determined using a method similar to that of ANSI Standard PH2.39-1977 (R1986).

RESOLVING POWER

Resolving power is a film emulsion’s ability to record fine detail. It is measured by photographing resolution charts or targets under exacting conditions. Spaces and lines identical in width separate the parallel lines on resolution charts from each other. The chart contains a series of graduated parallel-line groups, each group differing from the next smaller or next larger by a constant factor. The targets are photographed at a great reduction in size, and the processed image is viewed through a microscope. The resolution is measured by a visual estimate of the number of lines per millimeter that can be recognized as separate lines.

The measured resolving power depends on the exposure, the contrast of the test target, and, to a lesser extent, the development of the film. The resolving power of a film is greatest at an intermediate exposure value, falling

off greatly at high and low exposure values. Obviously, the loss in resolution that accompanies under- or over-exposure is an important reason for observing the constraints of a particular film when making exposures.

In practical photography, system resolution is limited by both the camera lens and the film; it is lower than the resolution of the lens or film alone. In addition, other factors such as camera movement, poor focus, haze, etc., also decrease maximum resolution. Resolving power values can be classified as follows:

(High Contrast Values in lines/mm)	ISO-RP Classification
50 or below	Low
63, 80	Medium
100, 125	High
160, 200	Very High
250, 320, 400, 500	Extremely High
630 or above	Ultra High

COLOR SENSITIVITY AND SPECTRAL SENSITIVITY

The term *color sensitivity*, used on black-and-white film data sheets, describes the film's sensitivity to the visual spectrum. All black-and-white camera films are panchromatic (sensitive to the entire visible spectrum). Orthochromatic films are sensitive mainly to the blue-green portions of the visible spectrum. And blue-sensitive (only) films are used to receive images from black-and-white materials.

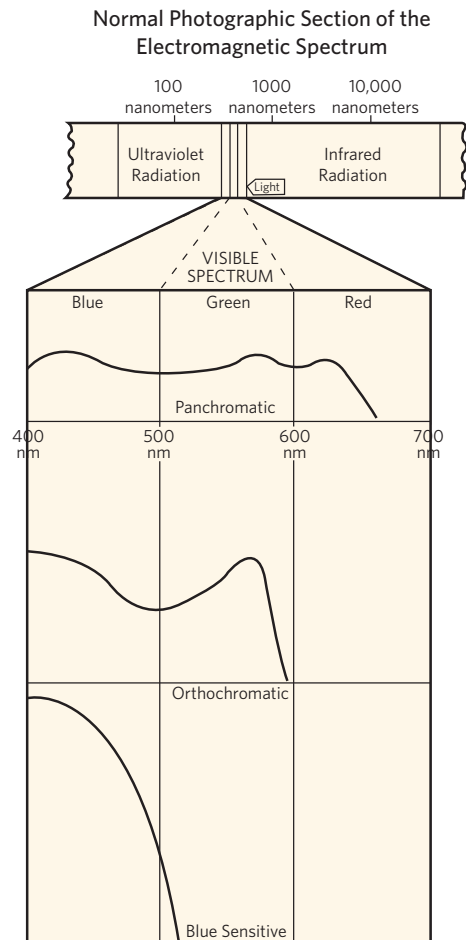

Panchromatic black-and-white films and color films, while sensitive to all wavelengths of visible light, are rarely equally sensitive to all wavelengths. Spectral sensitivity describes the relative sensitivity of the emulsion. This is especially evident when you compare the spectral sensitivity curve of a tungsten-balanced film to a daylight-balanced film:

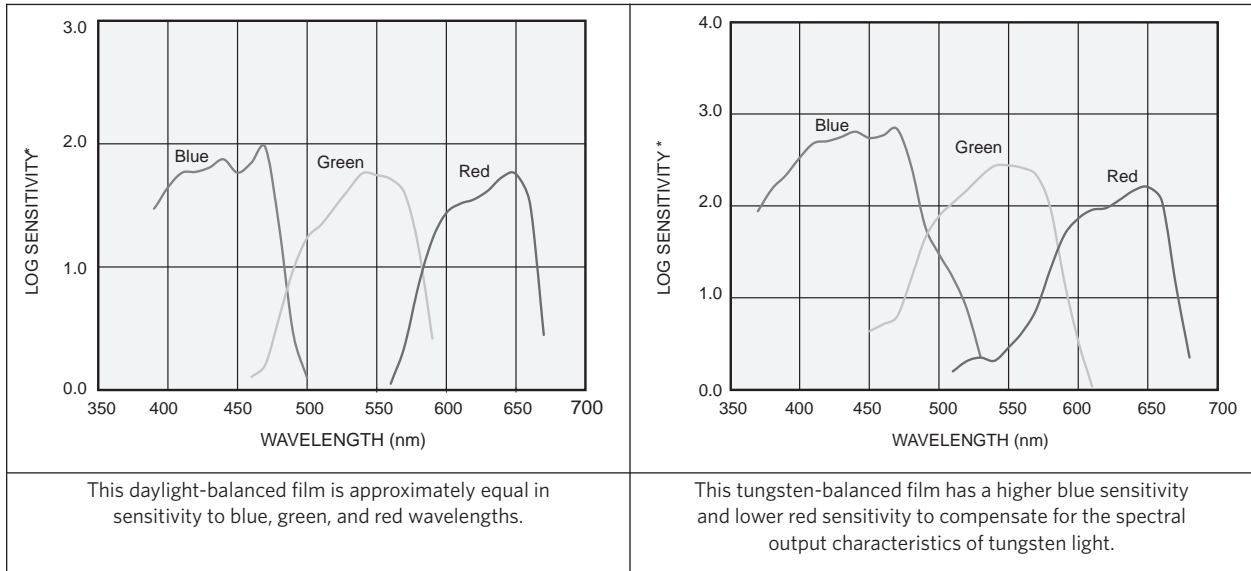

SPECTRAL DYE DENSITY

Processing exposed color film produces cyan, magenta, and yellow dye images in the film's three separate layers. The spectral-dye-density curves indicate the total absorption by each color dye measured at a particular wavelength of light and the visual neutral density (at 1.0) of the combined layers measured at the same wavelengths.

Spectral-dye-density curves for reversal and print films represent dyes normalized to form a visual neutral density of 1.0 for a specified viewing and measuring illuminant. Films which are generally viewed by projection are measured with light having a color temperature of 5400K. Color-masked films have a curve that represents typical dye densities for a mid-scale neutral subject.

The wavelengths of light, expressed in nanometers (nm), are plotted on the horizontal axis, and the corresponding diffuse spectral densities are plotted in the vertical axis. Ideally, a color dye should absorb only in its own region of the spectrum. However, all color dyes absorb some wavelengths in other regions of the spectrum. This unwanted absorption, which could prevent unsatisfactory color reproduction when the dyes are printed, is corrected in the film's manufacture.

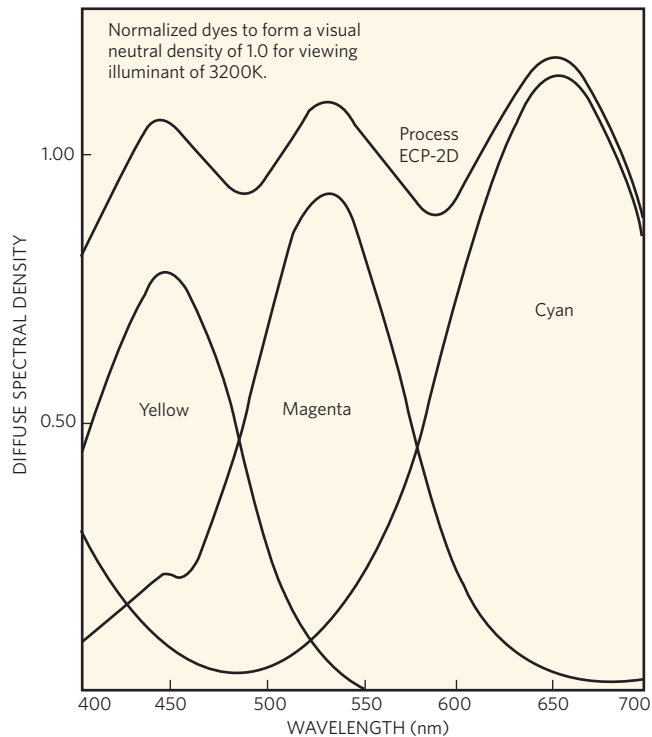

In color negative films, some of the dye-forming couplers incorporated into the emulsion layers at the time of manufacture are colored and are evident in the D-min of the film after development. These residual couplers provide automatic masking to compensate for the effects of unwanted dye absorption when the negative is printed. This explains why color negative camera films look orange.

Since color reversal films and print films are usually designed for direct projection, the dye-forming couplers must be colorless. In this case, the couplers are selected to produce dyes that will, as closely as possible, absorb only in their respective regions of the spectrum. If these films are printed, they require no printing mask.

DIMENSIONAL STABILITY

Film dimensions are influenced by variations in environmental conditions. Films swell during processing, shrink during drying, and continue to shrink at a decreasing rate, to some extent, throughout their life. If film is properly stored, dimensional changes can be kept to a minimum.

Dimensional changes are either temporary or permanent. Both are largely dependent on the film support. However, humidity changes can have a marked influence on the film emulsion, as it is far more hygroscopic than the base.

Temporary Size Changes

Moisture

Relative Humidity (RH) of the air is the major factor affecting the moisture content of the film, thus governing the temporary expansion or contraction of the film (assuming constant temperature). In camera films, the humidity coefficients are slightly higher than in positive print films. For ESTAR Base films, the coefficient is larger at lower humidity ranges, and smaller at higher humidity ranges. When a given relative humidity level is approached from above, the exact dimensions of a piece of film on cellulose trial support may be slightly larger than when the level is approached from below. The opposite is true for ESTAR Base films, which will be slightly larger when the film is preconditioned to a lower humidity than it would be if conditioned to a higher humidity.

Temperature

Photographic film expands with heat and contracts with cold in direct relationship to the film's thermal coefficient.

Rates of Temporary Change

Following a shift in the relative humidity of the air surrounding a single strand of film, humidity size alterations occur rapidly in the first 10 minutes and continue for about an hour. If the film is in a roll, this time will be extended to several weeks because the moisture must follow a longer path. In the case of temperature variations, a single strand of film coming in contact with a hot metal surface, for example, will change almost instantly. A roll of film, on the other hand, requires several hours to alter size.

Permanent Size Changes

Age Shrinkage

It is important that motion picture negatives, internegatives, and color prints have low aging shrinkage for making satisfactory prints or duplicates even after many years of storage. In positive film intended for projection only,

shrinkage is not critical because it has little effect on projection. The rate at which age shrinkage occurs depends on storage and use conditions. Shrinkage is hastened by high temperature and, in the case of triacetate films, by high relative humidity that aids the diffusion of solvents from the film base.

Processed negatives made on stock manufactured since June 1951 have the potential for lengthwise shrinkage of about 0.2 percent, generally reached within its first two years; thereafter, only inconsequential shrinkage occurs. This very small net change is a considerable improvement over the shrinkage characteristics of negative materials available before 1951 and permits satisfactory printing even after long-term storage.

Curl

Curl toward the emulsion is referred to as positive. Curl away from the emulsion is negative. Although the curl level is established during manufacture, it is influenced by the relative humidity during use or storage, processing and drying temperatures, and the winding configuration. At low relative humidities, the emulsion layer contracts more than the base, generally producing positive curl. As the relative humidity increases, the contractive force of the emulsion layer decreases—the inherent curl of the support becomes dominant. Film wound in rolls tends to assume the lengthwise curl conforming to the curve of the roll. When a strip of curled film is pulled into a flat configuration, the lengthwise curl is transformed into a widthwise curl.

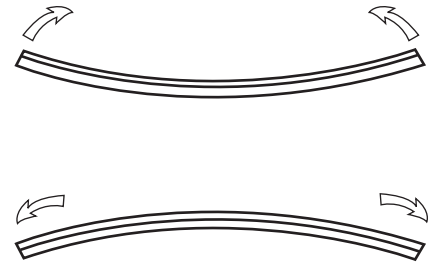

Buckling and Fluting

Very high or low relative humidity can also cause abnormal distortions of film in rolls. Buckling, caused by the differential shrinkage of the outside edges of the film, occurs if a tightly wound roll of film is kept in a very dry atmosphere. Fluting, the opposite effect, is caused by the differential swelling of the outside edges of the film; it occurs if the roll of film is kept in a very moist atmosphere. To avoid these changes, do not expose the film rolls to extreme fluctuations in relative humidity.

“This film (KODAK VISION2 Color Negative Film) definitely proves that the “film look” is not about grain but exposure latitude. There’s no grain to speak of—it’s the finest-grained film I’ve ever seen, with perfect color rendition, natural skin tones, a huge range of exposure, highlights that don’t burn out, and shadows that are rich and dark but with visible subtle detail.”

—Jon Fauer, ASC

MOTION PICTURE CAMERAS AND LENSES

THE CAMERA

Cameras are light-tight boxes that admit controlled light only through a lens, creating a series of individual frames as film is moved into place behind the lens. The film is held steady during exposure, and then advanced. Conceptually, motion picture cameras haven't changed for more than a century.

Some critical points:

- Film must be accurately placed, perfectly flat, and remain stationary during exposure for even, focused exposure to occur.
- The timing and accuracy of the aperture must be precise, especially for synchronous sound filmmaking. Even when sound isn't used, any variation in camera speed will affect exposure.
- The camera's moving parts must transport the film at virtually any speed required for the cinematographer's desired effect, without damaging the film.



Edison's first movie camera accomplished these objectives. But comparing that camera to a contemporary model would be analogous to Ford's Model T and a Ferrari. Both are automobiles, but their capabilities and precision set them worlds apart. Yet each can be driven to the supermarket when necessary.



Because the basic film formats of 35 mm and 16 mm / Super 16 mm film are universal, a properly working older camera will likely suffice.

To look at the essential components of a motion picture camera, we'll follow the film's path through the camera:



Lightproof housing

To prevent unintentional film fog, a camera body must be lightproof. Most cameras use a detachable lightproof magazine to hold large rolls of film; e.g., 400 feet for 16 mm or 1000 feet for 35 mm.

Fixed or Variable-Speed Motor

Motors deliver precise frame rates. This drives the sprocketed wheels of the precision movement. On a more advanced camera the speed is displayed on a tachometer.

Movement

The precision movement is directly linked to the rotation of the shutter, and manages the flow and timing of the film transport. The film undergoes two exposure cycle phases:

Advancement—moving the film from one frame to the next

Registration—holding the film rock steady during exposure

Advancement is controlled by a pull-down claw, which moves the frame that was just exposed beyond the gate, and brings the next frame to be exposed into position. Movement occurs when the shutter is closed.

Registration is controlled by the one or more registration pins that engage a perforation and hold the film steady for exposure. An alternate method uses magnets. Either way, registration is the opposite of movement. Because any film movement will result in a blurred image, it's critical that the film remain still during exposure.

THE SHUTTER

A camera shutter controls the light reaching the film. The registration pins hold the film completely motionless when the shutter is open and exposure occurs. The shutter is closed when the camera advances the film to position the next frame for exposure.

In motion picture cameras, the most common shutter is a rotating disk with a section removed. The shutter opening is defined as the number of degrees that are removed from a 360-degree disk. A 180-degree shutter—one-half circle—is the most common. Motion picture film cameras have variable rates, but most expose film at 24 frames per second. A camera with a 180-degree shutter allows light to strike the film half the time.



Variable shutter-type motion picture cameras allow the shutter angle to be changed. Decreasing the shutter angle, from 180 to 90, reduces the shutter opening by half, and also halves the exposure time.

There are several reasons for changing the shutter angle:

- A small shutter angle results in a faster shutter speed. Action is stopped and seen clearly. Motion blur is avoided.
- The frequency of some flickering lights, such as older HMIs, require shooting at a 172 degree shutter angle to eliminate flicker.
- Using an electronically adjustable shutter in a ramping shot (where the frame rate changes during the shot) the shutter changes as the frame rate changes in order to compensate for the exposure effect of the speed changes.

THE GATE

The gate is a metal plate that comes in contact with the film. Its rectangular aperture allows the image to fall only on the picture area of the film. The ratio of the width to the height is called the shooting aspect ratio.

Formats: Gate and Movement

The gate and the movement of a camera are two of the primary contributors to the film's format. The amount of film that moves through the camera is the same in the 16 mm and Super 16 mm formats, but the gate sizes are different.

In 35 mm cameras the gate and the movement differ. Most 35 mm format cameras advance the film 4 perfs at a time and expose the width of the film and a height of 4 perfs. The gate matches that size. Other camera formats move more or less film and have appropriately sized gates. A 3-perf camera system, for example, advances the film 3 perfs at a time and the gate aperture will only be 3 perfs high. It's important to note that the same 35 mm film is used in each camera; only the movement and camera gate aperture differ.

THE VIEWING SYSTEM

A viewing system is required so the camera operator can monitor the area of the scene being photographed. There are two basic types of viewing systems: parallax and reflexive.

Parallax viewing systems consist of a rangefinder that is attached to the side of the camera. These are most often found on older film cameras. This viewing system does not display the same image that is being exposed through the lens.

Reflexive viewing systems display the image that is being seen through the lens. Just as in SLR cameras, the motion picture camera uses a mirror or prism to redirect the light collected by the lens to the operator's viewing system. In this way, the camera person sees the actual image that the film "sees."

Reflexive viewing is accomplished in two ways:

A **prism** is placed in front of the gate and splits any light coming through the lens; the light continues toward the film and into the eyepiece. This system, unfortunately, places one more optical element between light and the film, and this can negatively affect resolution and the amount of light reaching the film.

Most modern cameras use a **shutter mirror**. The mirror is placed on the back of the shutter at an angle that reflects light coming through the lens to the eyepiece. When the shutter is closed the mirror reflects all light transmitted by the lens upward into the viewfinder. This system has less negative effect on exposure and image quality.

Video Tap

Most modern cameras have a video tap or video assist that is used to show a video representation of what is seen in the viewfinder. This is accomplished by splitting the light that is sent to the viewfinder by the shutter mirror or prism.

Footage counter

The footage counter indicates the amount of unexposed film left in the camera. This is usually a dial that indicates how many feet have been exposed from the start of the roll.

Camera Code

Today's more advanced cameras record time code data directly onto the film. This allows the post house to synchronize the sound automatically.

THE LENS

A light-tight box with film in it doesn't require a lens to expose film—even a pinhole camera can capture an image. But a lens can gather more light than a pinhole. A lens can focus and clarify. It's the tool we use to define our image.

Scientists and photographers have studied the lens since the early Twentieth Century. Few will describe any lens as technically perfect, although a lens' unique optical characteristics make it the best choice for a particular shoot.

Lens function is complex. We know that since all visible objects reflect light rays in all directions, we must gather as many rays as possible and get them to our film without distortion. Simple lenses use a single convex glass element positioned so that the light rays from the subject are bent towards and converge at the film. By carefully placing the lens relative to the film, we successfully record an image.

An iris is an aperture of variable size used to control the intensity of light falling on film. The iris control is usually calibrated in f-stops or T-stops. A change of one f-stop or T-stop is equivalent to doubling or halving the intensity of light falling on the film. T-stops are more accurate because they factor for light loss through the lens glasses.

T-stops are calculated by measuring the actual amount of light traveling through the lens and therefore allow for light loss through the lens glasses and are, therefore, more accurate. F-stops are a mathematical estimation of light that will travel through the film aperture.



Simple lenses have a limited ability to focus light. Optical distortions can result when light rays enter from the lens perimeter; those rays have to travel farther to reach the film and will be less focused. To a limited degree we can solve this problem by narrowing the glass width; the resulting loss in light, however, makes the lens “slower.” For each additional stop of light passage in a given lens, the design becomes more complex—the geometric correction becomes more extreme.

Standard, wide-angle, telephoto, and zoom lenses include the ability to adjust focus and iris. Some lenses include a second element, positioned between the first element and the film. Its concave surface compensates for the distortion of the first element. Each element introduces distortion, typically resulting in internal reflection, or flare. The distance between these elements and the precise grind of the glass is critical, and these factors add significant cost to the lens.

An aperture controls the quantity of light passing through a lens. The best lenses perform well at every aperture setting. As such, the precision of the lens must be consistent at every point within each glass element.

Dr. Max Berek of Leitz established image quality standards before 1914 by capturing “miniature” still photographs on 35 mm film. His “circle of confusion” defined the measure of permissible out-of-focus quality in a ten-inch paper photograph. Though modified, this concept endures.

Color is probably the most complex factor in lens design. Because each color has a specific wavelength measured in nanometers, a particular shade has a unique wavelength. Blue objects and red objects will focus in different places on a film frame, whether the film is black-and-white or color. Getting all colors to converge on a single plane despite their different lengths is fundamental to lens design. In 1938 Kodak pioneered the concept of making glass lenses with exotic types of rare-earth elements and cementing them together in each element to correct the aberration.

Zoom lenses were developed later. A good zoom lens must address each of the potential pitfalls while offering the utility of variable focal length. In motion picture applications, the light transmission, sharpness and individual color focus must remain unchanged despite the focal length change within a shot.

Focal Length and Focus

Lenses are identified by their focal length in millimeters and maximum aperture in f-stops (e.g., 50 mm/f1.4 lens). The focal length is defined as the distance from the optical center of the lens to the film plane. The f-stop is calculated from the dimensions of the lens.

Focal Length and Angle of View

The focal length of a lens determines the angle of view, or perspective, seen through the lens. Normal lenses provide a perspective that approximates human vision.

Lenses that are shorter than normal provide a wider angle of view—they are wide-angle lenses. Lenses that are longer than normal provide a narrower point of view and magnify the subject—they are telephoto lenses. Wide-angle lenses make background objects appear further away; telephoto lenses compress distance and make the background appear closer. Thus, moving the camera toward a subject (as in a dolly move) results in a look that is very different from a scene captured by zooming the lens from a stationary camera position. The apparent separation from the background, making objects relatively smaller, makes camera movement less noticeable. Thus, using wider lenses for hand-held scenes is preferable.

FOCUS

Three important concepts are used in discussions of lens focus: the Circle of Confusion, Depth of Field and Hyperfocal Distance.

Circle of Confusion

In its simplest definition, circle of confusion is the measure of a permissible out-of-focus quality in a photograph. For instance, a photographic image of a point source of light is not a true point, but a small patch of light. Though, to our eye, it appears like a point. If other point sources were photographed closer or farther away, they might appear as a larger light patch or circle. Circles, that are smaller than 1/1000 inch “confuse” our eye and they appear as points in focus.

Which circle of confusion you use depends on the gauge of the film stock and the lens quality. When using sharper lenses with contrasty lighting, you might use a 1/1000 or 1/2000 inch. Lenses of lower quality or when using effects filters, it is possible to use a larger circle of confusion, such as 1/500 inch.

Depth of field tables use the circle of confusion as part of the calculation.

Depth of Field

Depth of field is the area between the closest and farthest points from the camera that are in acceptable focus. When the focus is set at a given distance, there is a range in front of and behind that distance which remains in focus. The cinematographer must understand how to calculate the depth of field for a given shot, and how to expand and shrink that depth of field, as necessary.

Film systems provide control over depth of field. The naturally shallow depth of field can be easily manipulated to create the look you want. Depth of field is used as a creative tool. In many scenes, there is so much depth of field for the viewer, that it is sometimes difficult to isolate where the audience should be looking. By using depth of field to control the image, you can isolate the character from the background.

There are several ways to determine depth of field:

- Depth of field tables.
- Manual calculators, which allow the user to approximate a depth of field by lining up the parameters on a type of slide rule.
- Computer software can calculate depth of field.
- “Smart lens” devices on some newer cameras show the depth of field directly on a small display mounted next to the lens.



PARAMETERS THAT AFFECT DEPTH OF FIELD

- Format size or target size
- Aperture
- Focal length
- Distance from camera

To REDUCE the depth of field:

- Use a larger format
- Use a wider aperture
- Use a longer focal length
- Reduce the focus distance (move closer)

Controlling the depth of field helps tell the story by allowing the viewer to focus on key elements of the scene. A large or wide depth of field (deep focus) is used to show the entire scene in focus. By opening the aperture, moving further back, and using a longer lens, the depth of field narrows, and the background and surrounding elements fall out of focus. This effect can dramatize a scene by calling attention to a lone sharp subject, rendering everything behind and in front of that object soft. This effect is often called Differential Focusing.

Hyperfocal Distance

Hyperfocal distance can be interpreted as the closest focus distance at which both objects at infinity and closer objects are in focus.

Focusing at this point provides the maximum depth of field for specific lens and T-stop combinations. When focused on the hyperfocal distance, the depth of field extends from one-half the hyperfocal distance to infinity.

35 mm CAMERA DEPTH-OF-FIELD and HYPERFOCAL DISTANCE										
LENS FOCAL LENGTH: 50 mm				CIRCLE OF CONFUSION = .001" (1/1000")						
F/stop	f/1.4	f/2	f/2.8	f/4	f/5.6	f/8	f/11	f/16	f/22	f/32
Hyperfocal Distance	230.7'	161.5'	115.3'	80.7'	57.7'	40.4'	29.4'	20.2'	14.7'	10.1

Example:

If you were shooting 35 mm film with a 50 mm lens at f/11 and you focused at the hyperfocal distance of 30 ft. (as determined from chart above), your depth-of-field would be from 1/2 the hyperfocal distance (15 ft.) to infinity.

Double System Diligence

By its very nature, film cameras are part of this ensemble known as double system. One system, the camera, registers the picture element of the story, while the other system, the sound recorder, handles the sound.

The apparent nuisance of slating and syncing is more than offset by the convenience of working without being tethered by cables and the advantage of state-of-the-art quality in each stand-alone system. Still, we need to resolve the issue of mating sound to picture. The matter is greatly simplified by our ability to name each frame of film.

“The film, the cameras, they go
anywhere. I’ve taken them to the
Sahara. I’ve taken them to the
Himalayas. I’ve taken them
everywhere.”

—*Pascal Wyn, Production Director*

PLANNING YOUR WORKFLOW

With the variety of capture and delivery formats available to you today, it is important to plan ahead and make informed choices that will lead to the best possible results.

Determining your workflow early in your project is the best way to build in flexibility *and options*.

A workflow is a group of processes—employing hardware, software, and people—that, when put into action, deliver an end result, or a portion of an end result. There can be workflows for every phase of filmmaking:

- Pre-production
- Production
- Post-production
- Distribution

There are four main types of motion picture workflows; they each require the blending of analog and digital tools during capture, processing, and output:

- Film capture to film delivery (e.g., Super 16, 16 mm or 35 mm to 35 mm)
- Film capture to electronic delivery (e.g., Super 16, 16 mm or 35 mm to HD or SD or Digital Cinema)
- Electronic capture to film delivery (e.g., 24p to 35 mm)
- Electronic capture to electronic delivery (e.g., 24p to HD or SD or Digital Cinema)

Today's filmmakers rely on post-production facilities as partners in the creative process of telling stories with moving images for:

- Scanning film and creating digital dailies/rushes
- Color management
- Adding a multitude of visual effects
- Removing or improving image artifacts

What do you need to know to help make the new motion picture filmmaking process more efficient?

When you choose your capture medium, remember that you are committing to a level of image quality that, for the most part, cannot be improved later. Capture at the highest resolution and you will expand your options in post and gain the greatest possible flexibility for distribution, based on your budget. You can't cost-effectively correct clipped or blown-out highlights in post-production, for example. It is expensive to compensate for shortcomings in electronic capture.

If you don't plan ahead, you'll spend most of your time fixing images instead of using the post-production process to tell your story. And, unfortunately, even the best post-production facility cannot fix everything. If you shoot in a

16 x 9 aspect ratio, as opposed to TV's 4 x 3, and a 4 x 3 ratio is what you need for your final product, you cannot fix this in post.

Here are some suggestions on how you can make the digital post-production process more efficient and work toward a great finish:

Choose a release format

Making this decision first will help you plan and budget your project. Your choice significantly affects production and the post-production workflow your project will take.

Involve the post house early

Before you shoot, discuss your project and budget with the post facility. Determine their capabilities and discuss all available options. Members of your post-production team can provide valuable insight and help establish a workflow for your project.

Capture at the highest resolution

When you choose your capture medium, you commit to a level of image quality that cannot be improved later. Capturing at the highest resolution will ensure image quality, flexibility, and distribution options through the whole post-production process.

Scan at the highest resolution

Scan at the highest resolution and bit depth. Images high in resolution and bit depth are robust and withstand image processing better. They also offer flexibility in final output and distribution.

Record at the highest resolution

Record film at the highest resolution, given your choice of release format. This will provide the best image quality in the final print or electronic output.

Know that you cannot fix everything in the digital post-production process

While you can fix many things in the postproduction process, there are some things you can't, such as shooting in the wrong aspect ratio or clipping in highlights. Making fixes in post takes time and money that affect the overall budget.

Plan your budget / Price your options

Plan your budget carefully. If budget is an issue, price the different options available. What image resolution will your project require? Does the lab offer digital color-grading sessions during nighttime or off-peak hours? Are there scenes that will require more time and attention than others?

“...huge strides have been made in the digital video image, but ... The reality is there’s still nothing like film.”

—*Tim Orr, Cinematographer*

FILMMAKING RESOURCES

The Laboratory/Post House

With today's growing reliance on the blending of digital technology and traditional film, the role of the lab/post house is becoming increasingly important. Previously, most of the creative decisions regarding the image were made on the set; there were fewer options in post-production. Now, more creative decisions can be made during post-production, which makes it critical to maintain a dialog with your laboratory.

Select a lab and talk to the lab manager before you begin shooting. You'll learn which options are available during and after your shoot. Today's lab technicians are dedicated to insuring consistent results. They keep up with the latest technologies and work with you to help you get the most out of your project.

Laboratory vs. Post House

Until recently it was necessary to work with several businesses to obtain motion picture services (laboratory, negative cutter, optical effects house, digital effects house, video post house, etc.). Today, many laboratories offer most of these services at one location.

Equipment: Rent or Buy

Most production companies rent the cameras, lenses, lights, and filters they'll need; they consider this the most economical and practical way to set up a film shoot. Most of the competitive equipment rental houses that exist throughout the world offer the major brands, and you'll typically find service and support available even on distant or remote locations.

Buying your camera and lighting package can also make sense, depending on your schedule and unique needs. Many fine cameras, lenses, accessories, and light and sound packages are available at reasonable prices in the used market. Extensive hands-on testing should confirm the equipment's condition and reliability before determining the final purchase agreement.

Rental Houses

Rental houses are great resources for new techniques and technologies. It's their business to know the latest advancements in optics and cameras, and they're always happy to discuss your varied options.

Who are the Typical Contacts at These Facilities and What Services do They Provide?

Although post-production facilities differ, most offer the following services:

Capture

Selected scenes are converted from film to digital data during film scanning, for film or electronic output. The data setting, or amount of image data resulting from the scan, is critical to the quality of the final output; i.e., the highest data setting can produce the highest output setting. Conversely, less data cannot effectively produce more data.

Processing

- Digital effects, including color management, are created and managed via the scanned, digital data with computer hardware and software, many of which are proprietary to the post-production facility. The best facilities can produce quality effects and accurately and consistently modify and manage color throughout image processing (often between many workstations, even at different geographical locations).
- Dustbusting may be performed, including wire removal and restoration.
- Audio that is recorded during image capture may require adjustment. Extraneous noise removal and general quality improvements are often performed. Soundtracks are usually added to a program during editorial or just before the final rendering or recording.
- Colorists modify color and contrast according to input from the cinematographer or the director.
- Conforming—off-line and on-line editing—is performed to join selected scenes in the appropriate sequence using an edit decision list (EDL).

Output

- Film recording takes place after image processing. The digital image data that was scanned, color-corrected, edited, and then possibly processed is recorded back to film via a film recorder. This step is the complement to the scanning step; what was film, then converted to data, becomes film once more.
- Digital video mastering, or rendering, also takes place after image processing. The digital image data that was color-corrected, edited, and then possibly processed gets rendered out to different file formats. The level of quality with which the data was captured, then modified and managed throughout image processing, determines the level of quality that can be distributed.

Insurance: Don't Shoot Without It

The equipment rental house will require a certificate of insurance naming their company as the loss payee. In the event that any of the equipment is lost or stolen, or involved in any personal injury or property damage, you and the rental house should be protected. Similar policies are advised even when you own the equipment. Obtain referrals to insurance providers that specialize in coverage for the entertainment business. Many filmmakers also secure negative insurance, which provides for loss or damage to the negative during transit or processing.

Post-production Contacts

An **account executive** or **bidding producer** is your initial contact at a facility. You discuss your project with them, and they develop bid information based on information they collect from their post-production supervisor and/or digital effects supervisor. They are responsible for your contract and for financial arrangements for the duration of your project.

A **producer** or **scheduler** is your main contact within the post-production facility. Their responsibilities include:

- Scheduling sessions
- Scheduling equipment
- Obtaining receivables (elements)
- Tracking elements in the facility
- Delivering the final product

A **post-production supervisor** or **digital effects supervisor** works for you and is your liaison to the post-production facility. They attend and supervise editing and color timing sessions, and they approve all of the work done at the facility.

Colorists are artists who work closely with the cinematographer or the director to color-correct the film.

Scanning and/or **recording technicians** optimize and operate the film scanners and recorders and ensure that the quality of the scans and/or recordings meet image quality expectations.

Editors execute the edit decision list (EDL), joining scenes together with cuts, dissolves, and effects.

Sound editors assemble the soundtracks, then edit them into the finished program.

Graphic artists execute the image processing. Their tasks may include:

- Compositing images
- Performing paint fixes
- Removing or improving image artifacts such as dustbusting, wire removal, etc.

TIPS ON SELECTING A LABORATORY

Generally, the laboratory that gets your business is the one whose capabilities best match the requirements for your particular job. Laboratories differ in terms of the technical services they offer, personnel, track record on similar projects, size and location, prices, and so on. Weigh all of these factors when selecting the right laboratory for the job at hand.

Every production has different requirements. The challenge is to find the lab that can satisfy the greatest number of your needs on schedule and within budget. There are a number of tradeoffs.

- **Consider the question of size.** The big lab can usually offer lower prices due to their large-volume operation, more complete in-house services, and excellent quality control. The small laboratory

usually offers custom handling and easy access to the right people for advice and counsel. But they may have to charge more to support their custom operation.

- **Consider the location.** If a laboratory is a significant distance from your shooting location, you will be faced with the potential hazards and increased costs of shipping valuable footage to and from the lab. Daily communications with the lab may also be more difficult.
- **Consider your confidence in the laboratory.** Look upon the selected laboratory as a silent partner in the production of your project. You should take the laboratory into your confidence, and keep them informed about the films and photographic techniques you use. Given this relationship, the laboratory can assist and simplify your endeavors. You should select a laboratory you believe takes your interests seriously.

Film Lab. Choose the One that Fits Best.

Shop around for a lab that will meet your needs. Most labs more or less provide the same basic menu of services—primarily processing, printing or transferring of your film. Beyond the basics, they may have a particular emphasis on the type of work they specialize in and resultantly have the particular equipment and experienced staff to deliver those specialties. i.e. Documentary and archival, Commercials and music videos, Features and television series. Some labs have built the majority of their business servicing student filmmakers. Consider your needs for the project from preproduction to distribution and find a lab that provides the best fit for your project and budget. By scheduling your lab services in advance and using overnight courier services you can usually have your dailies/rushes back within 24 hours or less. Most labs will have a demo reel giving you an idea as to the type of services and results that they are delivering to their clients.

These important steps in your production can be smoothed considerably if you establish adequate communications right from the start. Both you and your laboratory should know what is expected—and when to expect it.

- **Know your needs.** Have a good idea of what you want from a laboratory and then talk about those needs with several laboratories before you make a choice. In your discussions, be sure to relay your ideas about such things as editing, dubbing, special effects, animation, etc., so the lab can help you accomplish these tasks in the best way possible.
- **Get acquainted.** Once you have made your choice of laboratories, get to know the people who will do your work. Tell them as much as you can about yourself, your needs, and your style. The more you communicate with them about yourself and your production, the better they can serve you.
- **Get it in writing.** Face-to-face discussions and telephone calls are necessary for efficient workflow; but when it comes to specifying what you want, when you want it, and how much it will cost, a carefully written document—the purchase order—is a must.

“Film cameras don’t tend to depreciate like video cameras. Video cameras are here today, gone tomorrow, next generation. With a film camera, the upgrade happens in the roll of film that you buy and put into it, and I find that is a wonderful way of upgrading your images by simply being able to put in a fresh roll of film stock.”

—*John Bowring, ASC*

FILM CREW



The Film Crew ... a typical crew engaged in a feature production.

PRE-PRODUCTION

During a feature production, a number of key people are brought into the project. The key roles and responsibilities include the following.

The creative stage of pre-production begins with the **Screenwriter**. A Screenwriter creates a screenplay (a written version of a movie before it is filmed) either based on previously written material, such as a book or a play, or as an original work. A Screenwriter may write a screenplay on speculation, then try to sell it, or the Screenwriter may be hired by a Producer or studio to write a screenplay to given specifications. Screenplays are often rewritten, and it's not uncommon for more than one Screenwriter to work on a script.



A **Producer** is given control over the entire production of a motion picture and is ultimately held responsible for the success or failure of the motion picture project; this person is involved with the project from start to finish. The Producer's task is to organize and guide the project into a successful motion picture. The Producer would be the person who accepts the Academy Award for best picture, should the movie win one. The Producer organizes the development of the film, and is thus quite active in the pre-production phase. Once production (filming) begins, generally the role of the Producer is to supervise and give suggestions—suggestions that must be taken seriously by those creating the film. However, some Producers play a key role throughout the entire production process.

The **Director** interprets the script and unifies the components of the film into something that bears his or her signature. This individual is like an orchestra conductor. The Director must be able to lead and control people, have them do what he or she wants them to do, yet remain on good terms. While in production, the Director not only oversees actors, but also advises the Director of Photography, instructs the major technical people, administrates the flow of people, consults on budgets, and deals with outside pressures. The Director is ultimately responsible for what happens on the set.

The **Director of Photography** (also **DP**, **DOP**, or **Cinematographer**) is responsible for the quality of the photography and the cinematic look of the film. The Director of Photography transforms the Screenwriter's and Director's concepts into visual images. Using his or her knowledge of lighting, lenses, cameras, and film emulsions, the Director of Photography creates the appropriate mood, atmosphere, and visual style of each shot to evoke the emotions that the Director desires. Working closely with the Director, the Director of Photography determines the camera angles, shot composition, and camera movement for every shot. The Director of Photography then decides upon the lighting equipment and the type and number of cameras that will be required for shooting. The Director of Photography orders the lights and cameras to be set up in such a way to attain the desired effect.

The creative side of pre-production includes "conceptualization." During this on-going process, a **Concept Artist** designs, plans, and sketches what the film will look like. The Concept Artist prepares the storyboard—a series of sketches that are used to visually illustrate the script. The sketches depict the key shots in the scripted scenes, including the framing, camera angle, blocking, character movement, as well as basic props and sets. During conceptualization, the Concept Artist also envisions and designs sets, characters, and costumes. Concept Artists often produce many thumbnail (small) sketches of different versions of objects or characters that are to appear in the intended film. The Concept Artist works closely with the Director, Producer, Director of Photography, and the entire art department.

The **Executive Producer** secures financing for a film. This person usually oversees business aspects but often has little actual involvement with the day-to-day operations of the filmmaking.

While the creative crew works on conceptualization, the **Production Finance Person** breaks down expenses and records expenses for every item for the production to keep the production within budget. (On smaller productions, the Producer or Associate Producer often performs this work.)

Costs are divided into above-the-line and below-the-line. For high-budget features, the general rule is above-the-line costs equal 75% of the budget. They are negotiated before production and are considered fixed costs. Above-the-line costs include salaries for the top creative talents and any rights to a book, play, or article. These are considered "fixed costs" because once they are negotiated, they won't change during production.

Below-the-line costs can equate to 25% of the budget. They cover everyday expenses to keep the production moving. Below-the-line costs are everything else, including crew, food costs during the shoot, housing, transportation, cameras, film stock and processing, editing, special effects, costumes, lighting, sets, props, and miscellaneous expenses.

The **Production Designer** works closely with the Director to make sure that the Director's creative vision can be put on film. The Production Designer, who heads the Art Department, is an artist responsible for creating the overall visual appearance of the film—the proper feel, the appropriate costumes, the right setting.

The **Art Director** reports to the Production Designer, and ensures that the actual location or set looks the way the Production Designer visualized it. The Art Director oversees the artists and craftspeople who build the sets, and is also responsible for costumes, make-up, and props.

A set is any scenery or environment built indoors or outdoors for use in a motion picture. The **Set Designer**, often a draftsman with architectural training, sketches plans and lists specifications for building sets based on the verbal descriptions or rough sketches provided by the Art Director. Because of the high cost of constructing sets, the set designer plans to build only what the camera can see.

The **Set Decorator**, who often has interior design experience, finds the appropriate objects to place within a set to make it look real, according to need, whether it's a businessperson's office or a hermit's shack.

Lead Man (or **Assistant Set Decorator**), who reports to the Set Decorator, takes the lead in tracking down various artifacts needed to decorate the set.

The **Swing Gang**, which reports to the Lead Man, is sent out to bring all the objects needed for the production back to the set.

The **Set Dresser** physically places the objects and furnishings—furniture, rugs, lamps, draperies, paintings, books, etc.—on the movie set, making it ready for shooting. The Set Dresser takes orders from the Set Decorator.

The **Construction Coordinator**, who reports to the Art Director, supervises the construction of a film's set to the Set Designer's specifications. The actual construction of a set can take many weeks or months, depending on the size and complexity of the required set. One decision that needs to be made is whether to shoot on location or on a set. This decision is made by the producer and/or director on a sequence-by-sequence basis.

The **Carpenter** takes orders from the Construction Coordinator and constructs the set to given specifications.

The **Carpenter's Assistant** reports to the Carpenter and helps build the set.

While the set is under construction, the **Costume Designer** conceives and draws designs for the costumes to be worn by the actors in the movie. The costume designs must be approved by the Art Director, Director, and Producer before going to the Seamstress, the person who actually makes the costumes.



The **Seamstress** makes the costumes based on the approved costume designs.



The **Casting Director** (or **Casting Associate**) suggests and evaluates potential actors appropriate for the film, sets up meetings with the actor and the Producer and/or Director, and often helps negotiate the terms of a proposed contract between the actor's agent or attorney and the Producer. When the actor is hired, the casting director helps negotiate the terms of a proposed contract between the actor's agent and the Producer.

A **Location Manager** scouts out locations for shooting and arranges for permission to shoot in specific places.

A **Technical Advisor** (or **Consultant**) may be hired by the Director for his or her expertise in a particular field to make sure that the movie portrays the particular events or situation accurately. A historian might be hired to make sure that a Civil War film is accurate. A lawyer may be consulted for courtroom scenes. A native of Laos may be asked to verify native customs or costumes. Or a biologist might be hired to check the accuracy of facts about the lives of dolphins.

If special effects, stunts, or animals are used, the film may also require specialized roles:

A **Special Effects Coordinator** (or **Special Effects Supervisor**) makes sure the special effects crew properly sets up effects according the Director's wishes.

A **Special Make-Up Effects** artist has expertise in combining make-up with special effects, such as squibs—small explosive devices that, when detonated, simulate the effect of a bullet, puncture wound, or small explosion.

A **Stunt Coordinator** is responsible for choreographing stunts and making sure the stunt is relatively safe, but still realistic.

Animals are sometimes used in movies. These animal performers often come with a **Trainer** or **Wrangler** who has either taught the animal to perform certain acts or entices the animal to perform by offering morsels of food. Several look-alike animals are often used for the same role. Clever editing makes an animal's random movements seem like they have a purpose.

The **Line Producer** runs the day-to-day operations. This person makes the deals for locations and transportation, secures extras for scenes, orders equipment, gets accommodations for the cast and crew when they're on location, and is on the set every day to ensure the production runs smoothly. The Line Producer is generally employed from pre-production through post-production and reports to the Producer.

Pre-production prepares everything needed for shoot:

- **Creative preparation** that includes scriptwriting to designing special props.
- **Financial preparation** that includes budgeting the film and finding the money to pay for it.
- **Administrative preparation** that includes arranging for people to be paid to ordering film and getting permits to shoot on location.
- **Physical preparation** that includes building sets, making costumes and arranging props.

After pre-production, the film goes into production.

PRODUCTION

During production, the actual film is shot. Many additional people and talents are involved:

The **Director of Photography** (also **DP**, **DOP**, or **Cinematographer**), who was involved in pre-production, has a major role in production. The prime responsibility during this stage is to light the set. Depending on the style of the Director, the Director of Photography may be left to decide the “look” of the film for him or herself or, after meetings with the Director and usually the Art Department, he/she may be left to light the set as he/she sees fit. Alternatively, the Director may have very firm ideas as to how the film should look, and if so, the Director of Photography must fulfill these wishes.

The Director of Photography has to set an example for the rest of the unit. Time keeping, crew behavior, dress, and manners all come, at least in part, from the Director of Photography and so set the standard for the professional approach of the crew.

The Director of Photography is responsible for all matters pertaining to the photography of the film: lighting, exposure, composition, cleanliness, etc. The Director of Photography will often “nominate” the crew; that is, he/she makes a list of first and second choice people to be offered the job. If crew members are “nominated” by the Director of Photography, then the Director of Photography is responsible for them and will have to fire them if

they are not up to the required standard. The up side of this is that Director of Photography usually gets the crew he/she wants.

The **Assistant Director** (also **A.D.**, **First Assistant**, or **First A.D.**) controls the shooting schedule and is responsible for keeping the production on schedule. By assuming responsibility for the routine tasks, such as the call (summoning the actors, crew, and logistical support to the correct place at the right time), the Assistant Director allows the Director to focus on the creative aspects of the film. The Assistant Director maintains order on the set, which is hopefully achieved by yelling "Quiet on the set!" The Assistant Director even has assistants of his/her own.

The **Second Assistant** (also **Second Assistant Director** or **Second A.D.**), the assistant of the Assistant Director, oversees the movements of the cast and prepares the call sheets—a list of actors who will be required for each scene, and when these actors will be needed. The Second Assistant tends to be a liaison between the set and production office. There can also be a Third Assistant (also Third A.D. or Second Second Assistant), who also assists the Assistant Director.

The **Second-Unit Director** stages large-scale action sequences that often deal with complex special effects and the participation of many extras, stuntpersons, and animals.

What would a motion picture be without its Actors? **Actors** play the character roles in the film. Some are well-known stars; many are newcomers.

A **Stand-in** is an individual who is similar in body structure and looks to the star Actor in a film and who takes that Actor's place during a lengthy setup—the placing of cameras, lights, and microphones—so the Actor can get ready for the filming itself.

A **Stunt Person** (or **Stunt Performer**), a specialist actor, actually performs stunts, which are often risky pieces of physical action. Stunts range from fight scenes to a fall from a cliff to a head-on collision with an oncoming truck. Many stunts are actually less dangerous than they appear because of appropriate camera angles, lenses, and editing.

The **Make-up Supervisor** (or **Make-up Artist**) is an individual in charge of make-up applied directly on the skin of an Actor for cosmetic or artistic effect. The Actor is made up before filming, but sometimes the make-up wears off during filming and new make-up must be reapplied. The job of the Make-up Supervisor is to maintain the appearance of the Actor's make-up throughout the filming.



The **Hair Supervisor** (also **Hairstylist** or **Hairdresser**) is responsible for maintaining Actors' hairstyles during filming.

The **Camera Operator** (or **Cameraman**) rolls the camera and stops it on cue, as instructed by the Director of Photography. The Camera Operator's responsibility is to achieve smooth camera movement and produce satisfactory pictorial images. To do so, the Camera Operator not only has to make sure not to bump the camera into other equipment while shooting, but also must be aware of how far the camera can tilt when filming a shot and where the boom—the pole that holds the microphone above a scene—is located so that it doesn't get in the shot.



The **Assistant Cameraman** (also **Assistant Camera Operator, First Assistant Cameraman**) assists the Camera Operator. This person maintains and cares for the camera as well as prepares an accurate camera log (also called camera report or dope sheets)—a record sheet that gives details of the scenes that have been filmed. On many camera crews, the Assistant Cameraman may also perform the duties of a Focus Puller and/or a Clapper-Loader.

The **Clapper-Loader** (or **Second Assistant Cameraman**) loads the camera with a new roll of film as needed, and operates the clapper board (clapboard for short)—a small hand-held chalkboard filmed at the beginning of each take. The “clapper” part of the job is deceptively simple. It is vital that all the information is on the clapperboard and that it is easily read.

It is critical that the Clapper-Loader keeps the inside of the changing bag or, on a big picture, the darkroom should be immaculately clean to keep dust and hairs off the film. The inside of the changing bag or the darkroom should be cleaned several times a day.

Perhaps the most important responsibility of the Clapper-Loader is the paperwork. The lab report sheet must be both legible and accurate or it will be impossible to find the appropriate piece of negative when it's time for negative cutting.

On most motion pictures, the Production Office keeps a very close eye on the daily camera report sheets. This is because the shot footage must be logged to see if the production is on budget in this area and to see how much footage is being entered in the “waste” column. A reputation for good paperwork is the most common reason for a Production Office to approve the Director of Photography's nomination of a Clapper-Loader.

An **Additional Camera** (or **B Camera**) is an extra Camera Operator who is sometimes needed for filming complicated action sequences, stunts from a different angle, or additional scene coverage with a second camera.

The **Sound Designer** oversees all the audio elements of a motion picture; similar to what a Production Designer does for the visual elements.

The **Sound Recordist** operates the sound-recording equipment on a set. Until recently, a Nagra recorder with a 1/4-inch tape was standard equipment; today digital audiotape, or DAT, is used. DAT is easier to synchronize and edit, and requires no Dolby or other noise reduction.

The **Boom Operator** operates the boom—a long, adjustable bar used to position a microphone during filming. On the boom, the microphone can be positioned above the actor's head, picking up dialog while remaining out of the camera's field of view. The Boom Operator must correctly position the boom microphone to record all the actors, which means pointing the mike at the actor who is talking, anticipating when the next actor will speak, and swiveling the microphone over to him or her.



The **Third Man** (also **Cable Operator** or **Cable Person**) operates the second microphone, if one is needed in a scene where actors stand far apart. The Third Man also handles all the cables related to sound-recording equipment—laying the cables, taping them, and tending the cables to follow the camera. In addition, this individual is in charge of noise abatement—discovering the extraneous noises, such as a refrigerator motor, a creak in the floor, or rustling clothing, and eliminating or minimizing them.

The **Key Grip** reports to the Director of Photography, oversees work with all of the camera support equipment on the set. This person supervises the Grips, who can number from five to fifteen.

A **Grip** works on the set with all of the camera support equipment. Grips prepare camera mounts so a scene can be filmed from whatever vantage point the Director of Photography desires. This might require organizing and securing the equipment needed to film from a moving car. Or this might necessitate erecting scaffolding for a high point of view. Grips work closely with the Electricians and Lighting Crew who set up the lights.

The **Dolly Grip** works with the dolly—a small four-wheeled truck that rolls along carrying the camera, some of the camera crew, and occasionally even the Director. If necessary, Dolly Grips lay dolly tracks, railings that guide the dolly in tracking shots outdoors. During the actual shooting, Dolly Grips push the dolly into the proper position at the appropriate moments.



The **Focus Puller** adjusts the focus of the lens as the actor moves closer to or further from the camera, or when the camera moves during a dolly shot. Keeping the main action sharp is the prime responsibility of the Focus Puller.

Before shooting begins, the Focus Puller marks the actors' positions on the floor with tape, and measures the distance between the lens and significant points in a traveling shot in order to attain a smooth "follow focus" during the take—a continuous recorded performance of a scene. The Focus Puller is responsible for setting the "Stop" as directed by the Director of Photography.

In addition, the Focus Puller is concerned with the camera itself. It is the Focus Puller's task to build the camera each morning and to put it away after shooting is finished. The Focus Puller must keep the lenses scrupulously clean and carry out any front line maintenance on the camera and its associated kit.

The Focus Puller rarely leaves the camera. The Camera Operator must be free to go off with the Director and the Director of Photography to discuss the coming set-ups. The Clapper-Loader brings the Focus Puller the bits of kit needed to build the camera for the next shot. You could say that during the shooting day, the camera "belongs" to the Focus Puller.

At the end of every "printed" take, the Focus Puller is responsible for giving whoever is on continuity the details of the shot. This includes the focal length of the lens, the focus setting, and the stop.

On any professional film set, the camera crew must always arrive at least half an hour before the call on the call sheet. The camera must be built and ready on the tripod or dolly before the call time and should be positioned roughly where the first shot of the day is expected.

The **Script Supervisor** (or **Continuity Person**) writes down very specific notes of every scene during filming so that he/she can look back at the notes during a later scene to check that all of the details are correct. The Script Supervisor makes sure everything looks the same from one shot to the next. The Script Supervisor also keeps track of the number of pages and scenes covered in a day, the number of setups, the estimated screen time, and notes how the filmed scenes deviated from the script—for example, how the dialog spoken by the actor differed from the written one.



The **Still Photographer** takes the still photographs that are used in publicizing the movie. Stills and instant photos are also used to help maintain continuity.

The **Gaffer** (or **Chief Lighting Technician**) heads up the crew responsible for lighting and other electrical matters during filming. The Gaffer reports to the Director of Photography and makes sure that his or her orders are carried out.



The **Best Boy** is the assistant to the Gaffer. This person orders all necessary lighting equipment and oversees the lighting crews.

The **Lighting Crew** (also **Lighting Technicians** or **Electrician**) is a group of technicians who install, operate, and maintain lighting. They retrieve the particular light that the Gaffer asks for, put it in position, raise or lower it, and wait for orders from the Gaffer to turn it on or off. If necessary, they add diffusing material in front of the light or adjust the width of the light beam by opening or closing the light's barn doors—black metal shutters attached to the light unit.

The **Genny Operator** sets up and operates a generator—a machine by which mechanical energy is changed into electrical energy.

FULL CREWS AND LOW-BUDGET CREWS

The structure of the technical crew varies from film to film, depending on the budget and the requirements of the script. Below are the two most common combinations of crew members.

The Full-Feature Crew

Camera:

Director of Photography
 Camera Operator
 Focus Puller
 Clapper Loader
 Dolly Grip

Lighting:

Gaffer
 Best Boy
 Lighting Crew
 Key Grip
 Grip Crew

Sound:

Sound Mixer
 Boom Operator

The Low-Budget Crew

On the “Low Budget” crew, the Director of Photography manages lighting and operates the camera. This is quite often the case on low-budget features and TV drama.

Camera:

Director of Photography
 Focus Puller/Loader

Lighting:

Gaffer
 Lighting Technician
 Key Grip
 Best Boy

Sound:

Sound Mixer
 Boom Operator

“That movie [Lost in Translation] was done with minimal equipment. When I met Lance [Acord] I had been accustomed to working on large-scale movies and being encumbered and enamored with all of the equipment, so much so that the humanity can get lost. I’ve since become very interested in working light. It’s not because of the economics, but rather because it brings you closer to your subjects. So often the machinery of our industry distracts us, and we lose touch with what we are hired to do. I find it truly rewarding to be able to get the striking results we achieved on this spot with such a simple approach.”

—Michael Williams, Director

FILM SPECIFICATIONS

Your camera will be the greatest determining factor of what specifications will be applicable to you. Many cameras (especially 16 mm) can only use or work best with certain cores or spools and have limits to the lengths of film they can use. For example, most H16 BOLEX Cameras can only use film that is on a daylight spool (R-90) that is no longer than 100 feet. So if you had a 90-foot short end of film on a core, your BOLEX could not use that film unless it was respooled.

COMMON FILM LENGTHS

There are some common lengths for each film gauge.

Super 8

Super 8 film is available in one specification: a 50-foot cartridge, single perf

16 mm

100' available only on camera spools (R-90)

200' available only for the AATON A-MINIMA Camera

400'

800' Note: Because most 16 mm camera systems are equipped with 400 ft magazines, a special magazine is required to use 800 ft spools.

35 mm

100' available only on camera spool (S-83)

200'

400'

1000'

65 mm

1000'



2500'

CORES AND SPOOLS

KODAK Motion Picture Films are available on several types of cores and spools, each appropriate to the design of the equipment used to expose the film.

A plastic core is typically used with all 35 mm films in lengths over 100 ft (30 m) and with all 16 mm films in lengths over 200 ft (61 m). Camera spools are supplied with some 35 mm x 100 ft (30 m) rolls and 16 mm x 100 ft (30 m). 200 ft (61 m) lengths of 16 mm for the A-MINIMA are wound onto spools specially designed for the A-MINIMA Camera.

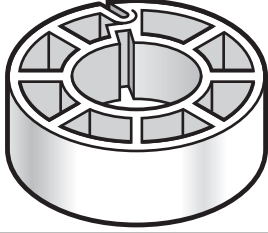
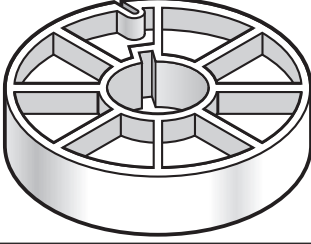
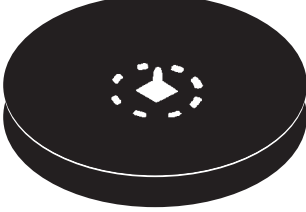
Standard core and spool types appear in the following table:

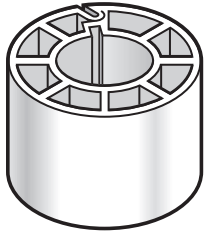
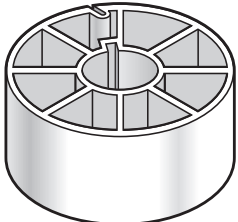
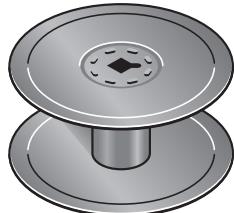
16 mm	
<p>Type T Core A plastic core with a 2-inch (51 mm) outside diameter and a 1-inch (25.4 mm) diameter center hole with keyway and a film slot. Used with films up to 400 ft (122 m) in length. This is the most common 16 mm core.</p>	
<p>Type Z Core A plastic core with a 3-inch (76 mm) outside diameter and a 1-inch (25.4 mm) diameter center hole with keyway and a film slot. Used with camera and print films in roll sizes longer than 400 ft (122 m) in length.</p>	
<p>R-90 Spool A metal camera spool with a 3.615-inch (92 mm) flange diameter and a 1 1/4-inch (32 mm) core diameter. Square hole with single keyway in both flanges. Center hole configuration aligns on both flanges. For 100 ft (30 m) film loads.</p>	
<p>KODAK Spool for AATON A-MINIMA Camera Specially-designed flexible flange 200 ft (61 m) plastic daylight spool. B-wind, emulsion out. Specific to the A-MINIMA camera consisting of 2 flexible flanges and a non-keyed 2-inch core. Can be loaded in subdued light without edge fogging.</p>	
35 mm	
<p>Type U Core A plastic core with a 2-inch (51 mm) outside diameter and a 1-inch (25.4 mm) diameter center hole with keyway and a film slot. This is the type of core you will find used with camera negative and reversal films.</p>	
<p>Type Y / EE Core A plastic core with a 3-inch (76 mm) outside diameter and a 1-inch (25.4 mm) diameter center hole with keyway and a film slot. Used with various lengths of print, intermediate, and sound recording films.</p>	
<p>S-83 Spool A metal camera spool with a 3.662-inch (93 mm) flange diameter and a 31/32-inch (25 mm) core diameter. Square hole with single keyway in both flanges. Center hole aligns on both flanges. For 100 ft (30 m) and 150-ft (46 m) film loads.</p>	

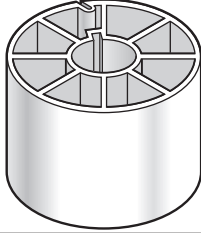
65 mm	
Type P Core A plastic core with a 3-inch (76 mm) outside diameter and a 1-inch (25.4 mm) diameter center hole with keyway and a film slot. Used with various lengths of print and intermediate films.	

PERFORATION SIZES AND SHAPES

There are three kinds of perforations used in motion-picture films:

Bell & Howell ("BH" or "N")	"Negative" perforation used on most 35 mm camera negative films. The Bell & Howell perforation evolved from early "round" perforations.
Kodak Standard ("KS" or "P")	"Positive" perforation. Larger size, rounded corners are used for extra strength. Used primarily for 35 mm release prints.
16 mm	Perforations are the same form (size and shape) for all film types; however, camera origination (negative or reversal) films have shorter pitch.

Bell & Howell's modification of the round perforation improved positioning accuracy and remained standard for many years. During this time, 35 mm professional motion picture cameras and optical printers were designed with registration pins that conformed to negative (BH) perforation and are still used today.

The high shrinkage of older, nitrate-based films made the negative perforation a problem on projection films; excessive wear and noise during projection occurred as the sprocket teeth ticked the hold-back side of the perforations when leaving the sprocket. The sharp corners also were weak points and projection life of the film was shortened. To compensate, a new perforation was designed with increased height and rounded corners to provide added strength. This perforation, commonly known as the KS or "positive" perforation, has become the world standard for 35 mm projection print films.

Each type of perforation is referred to by a letter identifying shape and by a number indicating perforation pitch dimension. Perforation pitch is the distance from the bottom edge of one perforation to the bottom edge of the next perforation. The letters BH indicate negative perforations generally used on camera and intermediate films, and on films used in special effect processes. The letters KS indicate positive perforations, which are used on most positive sound recording films and color print films.

Camera films may be perforated along both edges (double perforated) or along only one edge (single perforated). All 35 mm camera films are double perforated. Films used in laboratories for intermediate and release prints are supplied in a variety of perforation formats. The letter R preceded by a number designates the number of rows of perforations in a strip (1R is one row, 2R is two rows, etc.). Some flexibility is possible in selecting double- or single-perforated film. It is possible to use double-perforated film in cameras having a single pull-down claw. It's possible to duplicate or print footage exposed on double-perforated film on single-perforation stock, if a photographic (optical) or magnetic sound track is to be added to the film. (NOTE: Do not use single-perforated film in equipment designed for double-perforated film.)

PERFORATION TYPES

Dimensions

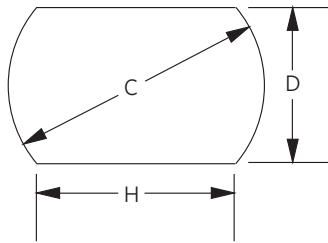

Bell & Howell (BH)

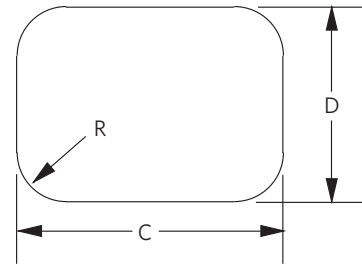

Kodak standard (KS)

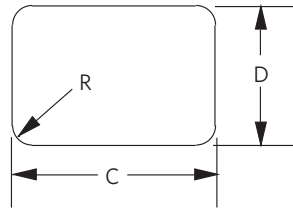

16 mm

Dimensions	Bell & Howell		Kodak Standard		16 mm		Tolerance ±	
	Inches	mm	Inches	mm	Inches	mm	Inches	mm
C	0.1100	2.794	0.1100	2.794	0.0720	1.829	0.0004	0.010
D	0.0730	1.854	0.0780	1.981	0.0500	1.270	0.0004	0.010
H*	0.082	2.08						
R			0.020	0.51	0.010	0.25	0.001	0.03

*Dimension H is a calculated value.

16 mm End Use Perforations

2R-2994—16 mm film perforated two edges with a perforation pitch of 0.2994 in. (7.605 mm), short pitch, ANSI / SMPTE 109-2003

2R-3000—16 mm film perforated two edges with a perforation pitch of 0.3000 in. (7.620 mm), long pitch, ANSI / SMPTE 109-2003

1R-2994—Same as 2R-2994 except perforated one edge, ANSI / SMPTE 109-2003

1R-3000—Same as 2R-3000 except perforated one edge, ANSI / SMPTE 109-2003

3R-2994—35 mm film perforated 16 mm with perforation pitch of 0.2994 in. (7.605 mm), short pitch, ANSI / SMPTE 171-2001

3R-3000—Same as 3R-2994 except with a perforation pitch of 0.3000 in. (7.620 mm), long pitch, ANSI / SMPTE 171-2001

35 and 65 mm End Use Perforations

BH-1866—35 mm Bell-Howell negative perforations with a pitch measurement of 0.1866 in. (4.740 mm), short pitch), ANSI / SMPTE 93-2005

BH-1870—35 mm Bell-Howell negative perforations with a pitch measurement of 0.1870 in. (4.750 mm), long pitch, ANSI / SMPTE 93-2005

KS-1866—35 mm and 65 mm Kodak Standard Positive perforations with a pitch measurement of 0.1866 in. (4.740 mm), short pitch, ANSI / SMPTE 139-2003; ANSI / SMPTE 145-2004

KS-1870—70 mm film perforated 65 mm Kodak Standard Positive perforations with a pitch measurement of 0.1870 in. (4.750 mm), long pitch, ANSI / SMPTE 119-2004

DH-1870—35 mm Dubray-Howell perforations with a pitch measurement of 0.1870 in. (4.750 mm), long pitch, ANSI / SMPTE 237-2003

WINDING

The film is wound on cores and the emulsion side of the film faces the center of the roll. All 35 mm camera films and some 16 mm camera films have perforations on both edges (2R in the sketch).

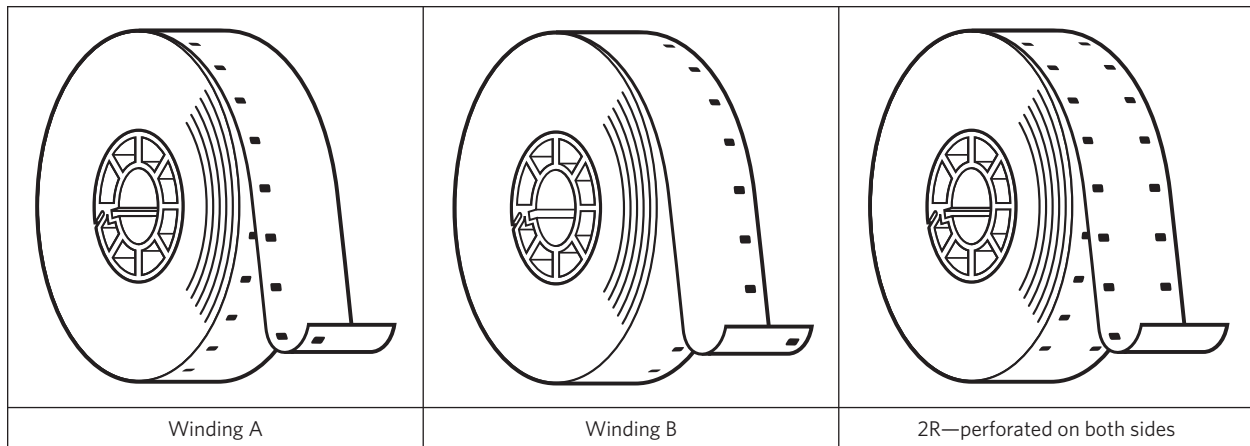

When a 16 mm roll of raw stock—perforated along one edge and wound emulsion side in—is held so that the end of the film leaves the roll at the top and to the right, it is designated Winding A if the perforations are toward the observer. It is designated Winding B if the perforations are away from the observer. Winding A films are used for making contact prints and are not intended for use in the camera. Winding B is for camera film, making optical prints, and on bi-directional printers.

FILM CAN LABELS

A film can label provides critical information about the enclosed film. The twelve-digit code on the label below (5201-001-011.01) identifies the film type (5201), the emulsion batch number (001), and the number of the roll and part (011.01) the film was cut from. The emulsion batch and roll numbers are repeated on film can sealing tape.

The Film Specification number, in this case SP 718, identifies the emulsion type; width; perforation type and format; winding; and type of core, spool, or magazine.

Film width, perforation pitch, emulsion position, and winding type are also identified on the label.

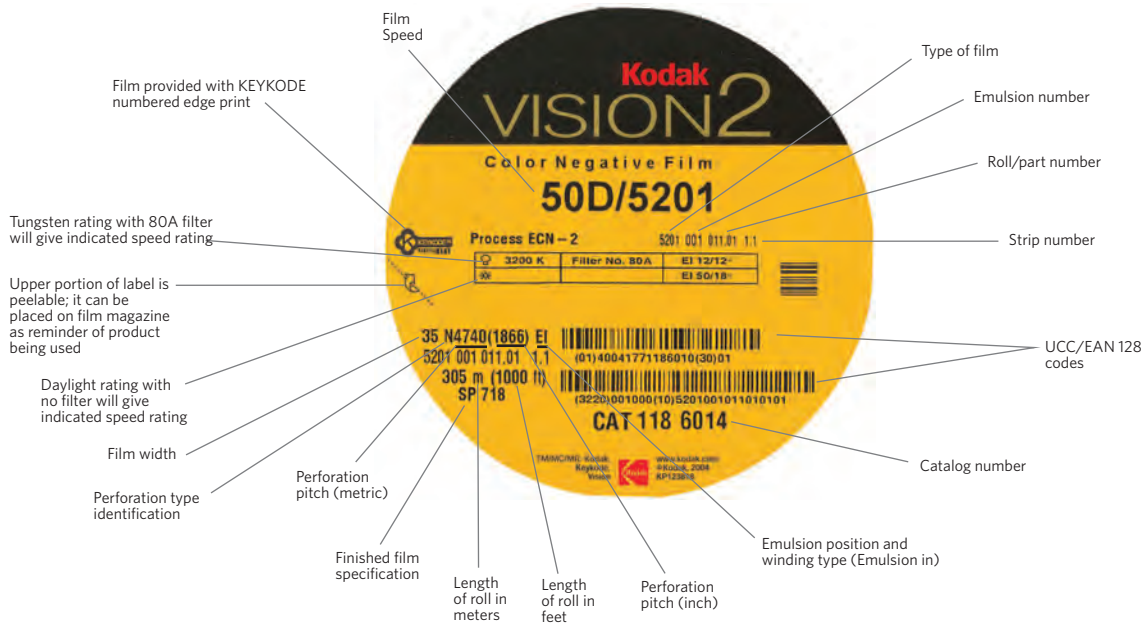

“The various film formats are just different brushstrokes. The right format is the one that will best bring the story across. Super 16 has advantages. You can really get in and out of setups quickly, and the smaller equipment is an advantage in small locations.”

—*Uta Briesewitz, Cinematographer*

FILM STORAGE AND HANDLING

Film seems to be derived from an old word for skin. Skin and film can be mistreated in similar ways:

- Skin can be scratched; so can film.
- Skin can be blistered by chemicals or heat; so can film.
- Skin can be damaged by prolonged exposure to the sun; so can film.
- Skin gets dry and brittle in low humidity and cold; so does film.
- Skin is susceptible to fungus in excessive heat and relative humidity; so is film.
- Skin can be burned; so can film.

But healthy skin and healthy film are strong, flexible and indispensable. We spend billions on skin care each year and know much about it. Why not consider film the same way?

STORAGE AND HANDLING OF RAW AND EXPOSED FILM

Keeping your raw stock and exposed film safe.

Raw Stock:

- Unprocessed film must be kept cool to preserve quality, ideally at 55°F / 13°C
- Keep film cool until just before shooting
- For storage of film for longer than 6 months, store at 0°F / -18°C
- Allow frozen film to warm up gradually before opening can, to avoid condensation
- Avoid prolonged exposure of film cans or camera magazines to sunlight
- Avoid storing film in hot vehicles

Exposed Unprocessed:

- Process film promptly after exposure
- Avoid "Latent Image Regression"
- Keep film cool after exposure
- If processing is delayed, put film in refrigerator
- Allow frozen film to warm up gradually before opening can for processing

The sensitometric characteristics of virtually all unprocessed photographic materials gradually change with time, causing loss in sensitivity, a change in contrast, a growth in fog level, a color balance shift, or possibly all of these. Improper storage will cause much larger changes in color quality and film speed than do variations in manufacturing. Scrupulous control of temperature and humidity, thorough protection from harmful radiation and gases, and careful handling are important to long, useful film life.

Exposed footage is even more vulnerable to the effects of humidity and temperature. It is recommended that it be processed promptly after exposure, to avoid changes known as “latent image regression”, which include loss of speed and contrast.

Temperature

In general, the lower the temperature at which a film is stored, the slower its rate of sensitometric change during aging will be. For periods up to three months, store motion picture raw stock at a temperature of 13°C (55°F) or lower, and a relative humidity of 60% or lower, during the entire storage period to retain optimum film properties.

Protect film in original packages or loaded in cameras, cartridges, magazines, on reels, and in carrying cases from direct sunlight. Never leave film in closed spaces that may trap heat. Temperatures in closed automobiles, parked airplanes, or the holds of ships can easily reach 60°C (140°F) or more. A few hours under these conditions, either before or after exposure, can severely affect film quality. If processing facilities are not immediately available, store exposed films at -18°C (0°F) but only for a few weeks at most.

Store raw stock at -18°C to -23°C (0 to -10°F) if you must keep it longer than three months or if you intend to use it for a critical use that requires uniform results. Sensitometric change cannot be prevented by such storage, but it will be minimized.

	Short Term (less than 6 months)		Long Term (more than 6 months)	
	Temperature	Relative Humidity	Temperature	Relative Humidity
Raw Stock (in original sealed cans)	13°C (55°F)	Below 60%*	-18 to - 23°C (0 to -10°F)	Below 50%
Exposed Unprocessed	-18 to -23°C† (0 to -10°F)‡	Below 20%	Not Recommended (see text below)	

*Keep sealed (in original cans) until temperature is above the dew point of outside air. (See table of warm-up times.)

†With possible loss of quality.

‡Process exposed film as soon as possible after exposure.

IMPORTANT: After a package of raw stock has been removed from cold storage, allow it to warm up to room temperature 21 +/- 3°C (70 +/- 5°F) before you unseal the can. This will prevent telescoping of the roll during handling because of possible cold-induced looseness between the layers; it will also prevent moisture condensation and spotting of the film.

Film Package	Typical Warm-up Time (Hours)	
	14°C (25°F) Rise	55°C (100°F) Rise
Super 8	1	1 1/2
16 mm	1	1 1/2
35 mm	3	5

Relative Humidity

Since a small amount of vapor leakage through the closure of a taped can is unavoidable, use additional water-vapor protection if you are going to keep motion picture films longer than a month in an area having high relative humidity (60 percent or higher), such as home refrigerators or damp basements. Tightly seal as many unopened rolls as possible in a second plastic container or can.

NOTE: It is the relative humidity, not the absolute humidity, that determines moisture content of film. Relative humidity is best measured with a sling psychrometer. In a small storage chamber, a humidity indicator, such as those sold for home use, is satisfactory.

When handling motion-picture film in high relative humidities, it is much easier to prevent excessive moisture take-up than it is to remove it. If there are delays of a day or more in shooting, remove the magazine containing partially used film from the camera and place it in a moisture-tight dry chamber. This prevents any absorption of moisture by the film during the holding period. Immediately after exposure, return the film to its can and retape it to prevent any increase in moisture content. Moisture leakage into a taped can is more serious when the can contains only a small quantity of film. When these circumstances exist, seal as many rolls as possible in a second moisture-resistant container.

Effects of Humidity

High humidity can promote mold growth and ferrotyping. Low humidity can create static marks when printing or cause buckling due to uneven moisture loss. Exposed film, particularly color film, deteriorates more rapidly than unexposed film. Kodak recommends exposing and processing all camera films soon after purchase and no longer than six months after purchase. Immediately after exposure, return the film to its can and retape the can to help prevent any increase in moisture content. Process the film as soon as possible after exposure.

Humidity lower than 50% usually increases static problems and dirt attraction to processed film. At very low humidity, film curl may become a problem (e.g., Newton's Rings).

Radiation

Do not store or ship unprocessed film near x-ray sources or other radioactive materials. Many scanning devices used by postal authorities and airlines will fog the film. Take special storage precautions in hospitals, industrial plants, and laboratories where radioactive materials are in use. You should also label packages of unprocessed films that must be mailed across international borders as follows: "Contents: Unprocessed photographic film. Please do not x-ray." In general the more sensitive the film stock the more susceptible it is to x-ray damage; i.e., the slower the film speed, the better. EI50 is safer than EI500.

Radiation effects are cumulative. The more x-ray exposure films receive, the greater the damage. Direct routing is preferable to indirect routing. A commercial carrier such as Federal Express or DHL will ship film without x-raying it, but they will inspect it carefully by hand.

Airport Security X-rays

Airports use x-ray equipment to scan checked and carry-on baggage. Film can tolerate some x-ray exposure but excessive amounts result in objectionable fog (an increase in base film density and a noticeable increase in grain). The faster the film, the greater the effects of the x-rays. Not only is there danger from x-rays, but security and customs agents may open containers of unprocessed film, ruining weeks of work.

You should never check your film with your luggage. X-rays used for checked baggage are more powerful than those used for carry-on inspection. With current security regulations your film will most likely be damaged if checked with luggage.

The traditional low dosage scanners which have been used at airports for many years to screen passengers' hand baggage are relatively safe for film up to a speed of EI200 for motion picture film or 400 ASA for still film. However, the effects of radiation are cumulative and film may be screened several times as the traveler passes

through various airports on a trip. Although tests have shown that 400 ASA still film was not affected by up to 7 passes through a RAPISCAN machine (one of the low dosage scanners), motion picture film may be affected to a greater degree by increases in grain and fog when the film is projected on a large screen.

For this reason, it is best to avoid all x-ray scanning of motion picture film.

Unfortunately, the volume of people passing through large airports on a daily basis renders hand-inspection all but impossible, and airport personnel are less willing to accommodate your special requests. If you plan to hand-carry unprocessed film through an international airport, contact the airport security office well in advance of your flight to make arrangements. Bring a light-tight changing bag in case it is needed. The changing bag will allow the inspectors to open the cans safely and inspect the film.

Once popular lead-lined carry bags are no longer practical—when inspectors can't see through the bags, they increase the x-ray intensity. Film, therefore, can suffer greater damage than routine inspection might have caused.

Suggestions for avoiding fogged film

X-ray equipment used to inspect carry-on baggage uses a very low level of x-radiation that will not cause noticeable damage to most films. However, baggage that is checked (loaded on the planes as cargo) often goes through equipment with higher energy x-rays. Therefore, take these precautions when traveling with unprocessed film:

- Request a hand inspection for all motion imaging origination films. Testing shows fog on motion imaging films even after a single x-ray scan. This increased fog flattens the entire toe region of the sensitometric curve, reducing shadow detail in a telecine or projected image. However, Explosive Trace Detection instruments provide no risk to motion picture films and can be used in conjunction with hand inspection to provide a non-destructive method of motion film inspection.

The Transportation Security Administration (TSA) recommendations for traveling with film may be found at www.tsa.gov.

The FAA provides air travelers in the United States the right to request a non-X-ray inspection of photosensitive products. For more information, see www.faa.gov. Remember that this only applies to air travelers in the United States.

Air Freight Services

We understand that express air package shipping services such as Airborne, DHL, FedEx, UPS, etc. that use their own aircraft, do not employ x-ray scanning of customers' packages on domestic routes. However, this should be verified when sending film. The same carriers may employ passenger airlines for international routes. Goods shipped as freight on passenger airlines are subject to high-intensity x-ray scanning. It is recommended that film shipped as unaccompanied freight is labeled "DO NOT X-RAY. IF X-RAY IS MANDATORY, DO NOT SHIP / DO NOT X-RAY / CONTACT SENDER URGENTLY: (details)".

Foreign Travel

Traveling internationally increases the amount of security measures at airports. Travelers should be wary of all scanners at foreign airports. You should allow for extra time at customs and security or call ahead to arrange an appointment for inspection.

It is best to plan ahead when shooting internationally. Have your film imported by an approved carrier. You can contact your nearest Kodak location to see about the best way to get film in the country you are shooting it.

Try to process the film in the country where you expose it. To find a local laboratory, contact the Kodak location nearest you.

Ambient Background Radiation (Effects on Raw Stock)

Ambient gamma radiation is comprised of two sources: a low energy component which arises from the radioactive decay, and a high energy component which is the product of the interaction of cosmic rays with the earth's upper atmosphere. Upon exposure to ambient background radiation, photographic materials can exhibit an increase in minimum density, a loss in contrast, and an increase in granularity. The change in film performance is determined by several factors, such as the film speed and length of time the film is exposed to the radiation before it is processed. A film with a speed of 500 can exhibit about three times the change in performance as a film with a speed of 125. While this effect on a film product is not immediate, it is one reason why we suggest exposing and processing the film as soon as possible after purchase. A period of about six months from time of purchase can be considered "normal" before exposure and processing, provided it has been kept under specified conditions. Extended periods beyond six months may especially affect fast films, as noted above, even if kept frozen. The only way to determine the specific effect of ambient background radiation is with actual testing or measurements and placing a detector in the locations where the film was stored. The most obvious clue is the observance of increased granularity, especially in the light areas of the negative.

Gases and Vapors

Gases (such as formaldehyde, hydrogen sulfide, sulfur dioxide, ammonia, coal gas, engine exhaust, hydrogen peroxide) and vapors (from solvents, mothballs, cleaners, turpentine, mildew and fungus preventives, and mercury) can change the sensitivity of photographic emulsions. The cans in which motion picture films are packaged provide protection against some gases, but others can slowly penetrate the adhesive tape seal. Keep film away from any such contamination—for example, closets or drawers that contain mothballs—otherwise, desensitization of the silver-halide grains or chemicals fogging can occur.

STORAGE AND HANDLING OF PROCESSED FILM

You can store exposed and processed camera films for a greater length of time than unprocessed exposed or unexposed film.

Processed Film Storage Conditions

	Short Term (less than 6 months)		Long Term (more than 6 months)	
	Temp	Relative Humidity	Temp	Relative Humidity
Processed B&W	21°C (70°F)	Below 60%	21°C (70°F)	20 to 30%
Processed Color	21°C (70°F)	20 to 50%	2°C (36°F)	20 to 30%

Effects of Humidity on Processed Film

Humidity lower than 50% usually increases static problems and dirt attraction to processed film. At very low humidity, film curl may become a problem (e.g., Newton's Rings—see text below).

Newton's Rings and Ferrotyping

Concentric bands of colored light sometimes seen around the areas where two transparent surfaces, such as two pieces of glass or two pieces of film (as in contact printing), are not quite in contact are called Newton's Rings. The rings are the result of interference and occur when the separation between surfaces is of the same order as the wavelength of light.

Ferrotyping describes a smooth and shiny blotch or series of blotches on the emulsion surface. It is caused by the presence of heat and/or moisture with pressure. Sources of ferrotyping can be improper drying conditions on the processing machine, the wound roll of film was wound under excess moisture (high humidity conditions), or the wound roll was subjected to high heat either before or after processing.

Effects of Contaminants

Certain gases such as formaldehyde, hydrogen sulfide, hydrogen peroxide, sulfur dioxide, ammonia, illuminating gas, motor exhaust, and vapors from solvents, mothballs, cleaners, turpentine, mildew or fungus preventatives, and mercury can damage unprocessed and processed film. Keep film away from such contaminants.

Handling

Do not store film near heating pipes or in the line of sunlight coming through a window, regardless of whether the room is cool or not.

Maintain the temperature as uniformly as possible throughout the storage room by means of adequate air circulation so that sensitometric properties remain consistent from roll to roll.

Handle film carefully by the edges to avoid localized changes in film sensitivity caused by fingerprints. Folding and crimping the film also introduces local changes in sensitivity. Keep the surfaces that the film travels over clean to prevent scratching of the film's base or emulsion.

Minimizing Damage to Film

Film equipment can damage film. Potential sources of damage in order of frequency are projectors, editing equipment, cleaning equipment, telecines, printers, and cameras.

General Precautions in Handling Film

Prevent damage to film by:

- Servicing equipment regularly.
- Cleaning all camera/projector film gates regularly.
- Cleaning and checking rollers and sprockets.
- Cleaning magazines regularly.

- Cleaning film regularly (see below).
- Edge waxing and/or lubricating film to reduce severe film wear.

Film Cleaning

It is a good idea to use particle transfer rollers (PTR) on film-handling equipment and to clean dust and particles off of processed film. It is best to use ultrasonic film cleaners, which are safer and more efficient than liquid hand cleaning or PTRs.

Hand cleaning—

- Use a soft cloth, non-abrasive material designed for the job.
- Only use an approved commercial film cleaner if “dry” cleaning does not remove the dirt.
- Never use carbon tetrachloride, methanol, or ethanol—they pose health and safety problems.

Treating Scratches

Scratches are virtually impossible to eliminate, but they can be minimized by:

- Reprinting with a liquid gate printer that hides base scratches and some light emulsion scratches.
- Re-washing the film for light emulsion scratches (Process RW-1).
- Lacquering (or “polishing”) base scratched film.

For a more detailed discussion of care and long-term storage of film, see KODAK Publication No. H-23, *The Book of Film Care*.

Extended Storage Time—10 Years or More

Color dyes are more prone to change than silver images when kept for extended periods of time. The following minimum guidelines are suggested for keeping films for 10 years or more.

Adequately wash the film to remove residual chemicals such as hypo. See ANSI PH 4.8-1985 for recommended levels and a testing method for residual hypo.

Some color films designed for processes other than ECN-2 and ECP-2E may require stabilization during processing (e.g., some reversal films using process VNF-1). Always follow recommended process specifications and formulas.

All film should be as clean as possible, and should be cleaned professionally. If you use a liquid cleaner, provide adequate ventilation. Adhere to local municipal codes in using and disposing solvents.

Keep film out of an atmosphere containing chemical fumes. See "Effects of Contaminants" above.

Do not store processed film above the recommended 21°C (70°F), 20 to 50% RH for acetate or polyester.

Wind films emulsion-in and store flat in untaped cans under the above conditions.

Additional information can be obtained from ISO 2803 or ANSI PH1 43-1985, "Practice for storage of processed safety photographic film."

EXPOSING FILM

Exposure is the action on the negative. Light strikes the film at certain points in the image. Where light strikes the silver halide grains, densities form. The more light, the greater the density. The greater the density, the more intense the exposure.

The factors that determine just how great a density will be on the negative are:

- **Exposure Time** is the length of time that film is exposed to light. In motion picture cameras, this is linked to the frame rate. When shooting sync sound at 24 frames per second, the exposure time is 1/48th of a second.
- **Film Sensitivity** is the ASA, or Exposure Index (EI), of a film. The faster the film, the larger and more sensitive the silver halide grains, and the higher its EI rating. It takes less light to make densities on faster films, and more light to make the same density on a slower film.
- **Aperture** is the size of the hole in the diaphragm through which the light passes in the lens.
- **Intensity of light** is a term that describes how much light that actually reflects off the subjects and is available for collection by the lens.

CONTROLLING THE VARIABLES

In order to achieve a normal exposure, we need to manipulate the above variables:

Variable	Which is...	e.g.
Exposure Time	expressed as a part of a second	1/48th
Film Sensitivity	expressed as a figure of exposure index	100 E.I.
Intensity of Light	expressed as a quantity of foot candles	100 f.c.
Aperture	expressed as an f/stop	f/2.8

Aperture

The aperture opening, sometimes referred to as the iris opening, is stated in stops (T-stops or f/stops) using the following numbers: 1.4, 2, 2.8, 4, 5.6, 8, 11, 16, and 22.

Stops

Stops can be thought of as calibrated foot-candles. They define the intensity (quantity) of light allowed to strike the film. A certain number of foot-candles bears little relevance outside its context as a variable in an exposure formula. When we say "one stop," we are expressing a quantity that is either twice as much light or half as much light.

T-Stops and F/Stops

When discussing lens aperture size, cinematographers usually refer to T-stops while still photographers refer to f/stops.

- The **f/stop** is a physical measurement of the theoretical ability of an ideal lens to pass light. By dividing the focal length of the lens by its iris diameter, the f/stop can be determined. Light, which is lost through the lens itself, is not considered in the f/stop calculation.

$$f/\text{stop} = \frac{\text{Lens Focal Length}}{\text{Diameter of Lens Aperture}} \qquad f/1.4 = \frac{50 \text{ mm}}{36 \text{ mm}}$$

- The **T-stop** is a measurement of the actual amount of light a lens will pass after allowing for transmission losses due to absorption, internal reflections and light scatter. T-stops are determined for each particular type of lens since lens design, quality of the glass, number of elements and lens coatings do vary. Therefore, T-stops are more accurate than f/stops.

What relates the two is the lens' efficiency in transmitting light. If the lens could transmit all the light entering it, its T-stop and f/stop would be the same. Light meters mathematically calculate exposure in f/stops. Once you have determined the proper exposure, you can set the lens to the correct T-stop.

Stops relative to exposure:

- the smaller the number, the bigger the hole
- the difference between the actual light that passes through the hole represented by any two consecutive stops is either double or half.

CALCULATING EXPOSURE

In motion picture cameras, the exposure time is linked to the frame rate, most often 24 frames per second. For that reason, we usually describe exposure time in terms of frame rate.

Identify the relationships between the variables in the following table:

fps	EI	f.c.	f/stop
24	100	100	2.8
24	200	50	2.8

Notice that the sensitivity of the film (EI) was doubled, so we required half as much light (f.c.) to arrive at the same exposure. Here's another:

fps	EI	f.c.	f/stop
24	100	100	2.8
24	50	200	2.8

CHANGING OTHER VARIABLES

You can change the f/stop, as well. Remember that opening the diaphragm of the lens by one stop actually doubles the amount of light passing through it. Conversely, closing it down by one stop halves the amount of light reaching the film.

fps	EI	f.c.	f/stop
24	100	100	2.8
24	100	200	4.0

Because f/4 allows half as much light to pass through the lens as does f/2.8, we must double the amount of light falling on our scene in order to arrive at the same exposure.

You can change more than two variables at once. For example:

fps	EI	f.c.	f/stop
24	100	100	2.8
48	400	100	4.0

Contrast refers to the tone separation in a negative (or print) in relation to a given difference in the light-and-shade of the subject from which it was made.

Latitude, in a photographic process, refers to the range of exposure that can be considered correct or useful.

Normal refers to an exposure judgement that accurately reproduces what we see. Usually we light faces of actors in order to make a normal exposure.

Generally speaking, the latitude of KODAK Color Negative Film is about 10 to 12 stops. That means that a face that is more than 5 to 6 stops darker than normal should appear simply as black, and a face that is 5 stops brighter than normal should look white.

To obtain the best exposure, err on the side of over-exposure to create a "bullet-proof" negative. It's better to provide too much information on the negative than too little.

Process, or processing, is the act of developing the negative. By causing the exposed negative to interact with several chemical agents, like developer, fixer and bleach, we convert the latent image into a tangible, malleable color representation.

CAPTURE - IMAGE PROCESSING - OUTPUT

The entire analog image chain is designed to accommodate a normal exposure, normal processing, and normal printing. In fact, the system is nearly foolproof and endlessly forgiving when everything operates under normal parameters.

Cinematographers usually operate very close to that line of normalcy. Small adjustments in one or more of the image chain "links," however, can produce interesting outcomes that provide precise and repeatable control over a great number of image parameters.

NORMAL EXPOSURE

Always attempt to get the best latitude, grain, color, and sharpness from the stock that you're using. A properly exposed negative will optimize all of these characteristics. Once you understand the film's limits and capabilities,

you can be more confident while making tough, on-the-spot shooting decisions. Occasionally, you will deviate from the normal exposure. Based on whatever look you are trying to achieve, you may opt to over or under expose the stock.

Consistent exposure minimizes dependence on the laboratory's ability to compensate; as exposure correction always results in a trade-off in some area of image quality. Occasionally, cinematographers eschew normal exposure in deference to the look they're trying to achieve; they may choose to over-expose or under-expose the stock.

When corrected to a normal image, over-exposure results in:	When corrected to a normal image, under-exposure results in:
<ul style="list-style-type: none"> ▪ Less apparent grain ▪ More saturated color ▪ Richer blacks ▪ Increased contrast 	<ul style="list-style-type: none"> ▪ More apparent grain ▪ Less saturated color ▪ Smoky blacks ▪ Lower contrast ▪ Less perceived sharpness

In his book *The Negative*, Ansel Adams states that under- and over-exposure refer to exposure errors, which is not always accurate. He preferred to use the terms increased or decreased exposure when referring to an intentional change from normal exposure.

“The stocks we’re working with today are so amazing. Most people who aren’t professionals can’t tell the difference between Super 16 and 35 mm, even with a 500-speed stock.”

—*Uta Briesewitz, Cinematographer*

EXPOSURE TOOLS

Measuring the amount of light in a scene helps the cinematographer select the camera settings that will best satisfy the creative intent. Accurate exposure is affected by the intensity of light striking the film and the length of time the shutter is open. Light intensity is affected by the lens opening (T-stop), the amount of light falling on the scene (incident light), and the strength of light reflected off the subjects (scene reflectance).

THE EXPOSURE METER

Light meters, or exposure meters, are offered in a variety of shapes, sizes, and styles.

Incident light meters are easy to use, because they tell us how much light is falling on them. Holding the incident light meter in the subject lighting, enter the exposure time and film sensitivity, and the light meter indicates normal exposure.

Exposure meters have two parts; a photometric sensor and a simple calculator. When we aim the meter at some light source and push the button, the measurement is taken (in foot candles) and incorporated into the calculation.

Most meters allow you to change one or more of the exposure variables, and it will reflect your changes in its suggested f/stop.

Incident light meters are designed to measure light falling onto the subject. **Spot meters** measure light reflected from the subject. If you understand the function of each meter, either one will give you very reliable, consistent results.



An incident light meter



A spot meter

- Incident meters conveniently give the correct T-stop when held in the subject lighting. Cinematographers differ in how to point the incident meter. Manufacturers often recommend pointing the white dome of their meters toward the camera. Contrary to this advice, some notable cinematographers always measure by pointing toward the main light source instead of the camera position. Their feeling is that more shot-to-shot consistency will be achieved by this method.
- All reflected light meters are calibrated to reproduce any reflected tone, whether it is black or white, as 18% gray density.
- The response of a photocell to light is not the same as color film's response. The meter may mislead you into accidentally under- or over-exposing the film, depending upon the predominant color of the scene.

- Cautions and reminders:
 1. Have your meters checked for accuracy over the entire scale. A small error can be tolerated if it is uniform over the entire range. An inconsistent response in a high light level vs. a low light level would mislead you in exposure.
 2. Spot meters use an optical system, so be sure to check for the accuracy of the spot indicator by reading a small bright area (such as a light bulb in the distance). The indicator should not move until the spot contacts the bright surface.
 3. Check spot meters for flare. Read a small dark surface surrounded by light surfaces. First, read it from a distance, then, from close up to fill the entire viewing area. If the reading is significantly lower at the close distance, flare should be suspected. Try a cardboard tube to shield the lens and reduce the chance of optical flare.

An 18% reflectance represents an average of all the reflectance values in a given scene. It can be thought of as a reflected value that falls halfway between a white object and a black object. Cinematographers sometimes meter an 18% gray card to determine the proper exposure for a subject. The gray card serves as a reference for the cinematographer when viewing the dailies. Using a gray card minimizes guesswork and helps to ensure more accurate color reproduction.

When setting up exposure meters, entering the correct variables is critical for optimal exposure. First, enter your film's EI. Next, enter the frame rate, which determines exposure time per frame. Most cine meters are set up for a 180-degree shutter, and calculations are based on this assumption. It's also important to compensate for any deviation from the 180-degree shutter angle and for any lens filters used. A shutter angle of 90 degrees, for example, requires one stop exposure compensation. Therefore, a film with an exposure index of 250 is entered as 125.

Using a Spot Meter

Spot meters allow the cinematographer to pick certain parts of the scene and measure the reflectance of that part of the frame. You should take your measurement from the camera axis to measure light entering the lens and onto the film plane.

Whatever you measure on a spot meter will read as middle gray whether it is or not in reality. For example.

- If you use your spot meter to measure something that is a middle tone (approximately 18% reflectance), you will get a normal exposure.
- If you measure something that is 5 stops over middle gray, like snow, your spot meter will interpret the snow at 18% reflectance and will calculate an exposure that is 5 stops under normal. The snow would come out looking like a middle gray instead of white.
- The same would happen if you measured the light reflecting off of something 3 stops under middle gray, like a black shirt. Your exposure would then be 3 stops over normal and the black shirt would be gray in your picture.

The point of all of this is to be aware of what you are measuring, and adjust your exposure accordingly.

THE GRAY CARD

To achieve normal exposure for an incident or reflection reading, an assumption about the reflectance of an average scene is made—that an “average scene” reflects 16% of the light. (This value was empirically derived by analyzing the reflectance of numerous scenes and computing the average.) A standard definition of “average scene reflectance” allows camera and meter manufacturers to build equipment that provides consistent results. ANSI standard PH2.12 explicitly specifies 16% average scene reflectance as the metering constant for incident and reflection meters.

Kodak studio photographers preferred 18% reflectance, one-sixth of a stop more than 16%, because it provided better results. Given the superior latitude of today’s films, an exposure difference of one-sixth of a stop is insignificant.

In the still photographic world, the gray card reading provides simple exposure information. In the motion picture world, the gray card performs an equally, if not more important task—providing a reference point to the lab or post house. An actual exposure of the KODAK Gray Card Plus helps the Colorist and Film Color Timer preserve the look the cinematographer captured on film and provides a neutral reference for exposure and color balance in telecine transfer set-up.

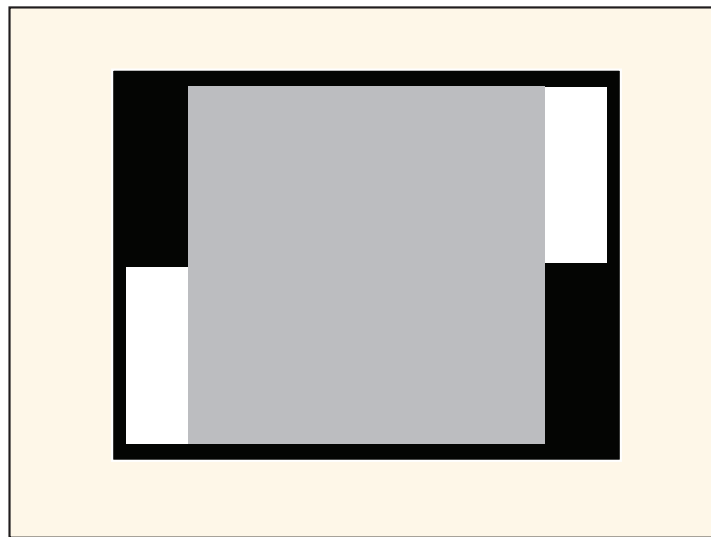

KODAK Gray Card Plus

The Gray Card Plus should be used in subject lighting, at the head of each roll, and every time there is a major lighting change.

- Position the card so it receives the same light intensity and color balance as the main subject and occupies at least 15% of the frame.
- Turn or tilt the card so it is evenly illuminated without shadows or flare. The color temperature of the light reflected from the card should match the scene.
- Determine the normal exposure for the scene using an incident light meter or the method that you prefer.
- Take a reflected spot meter reading on the gray portion of the card from the camera position. If necessary, reposition the card or add supplemental light for a reading that agrees with the aperture you have chosen for a normal exposure.
- Shoot the card including some of the scene, if possible, as a reference.
- Repeat this procedure at the head of each roll and every time there is a major lighting change.

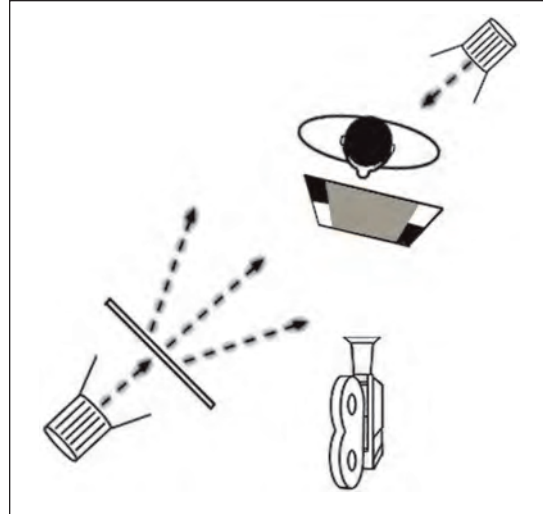

Gray Card Plus shot with separate light

If placing the Gray Card Plus in the scene doesn't provide an accurate exposure reference, set up lighting for the card that's separate from scene lighting (scenes that are cross-lit or lit mainly from a backlight). The card is placed in a C-stand or is held steady near the camera and lit with the same color temperature as the scene lighting. The Gray Card Plus is also used when the lighting doesn't match the color balance of the film (when shooting under fluorescent lighting or warm, household incandescent lights without correction filters).

- This may be necessary when an accurate exposure reference can't be achieved by placing the card in the scene (scenes that are cross lit or mainly from a backlight).
- Place the card in a C-Stand or have a steady handed grip carefully hand-hold it near the camera. Light the card with a unit of the same color temperature as the scene lighting.
- Tilt the card, if necessary, for even reflectance.
- As stated in the above example, take a spot meter reading from the camera position. Adjust the card and/or light to match the incident meter reading.

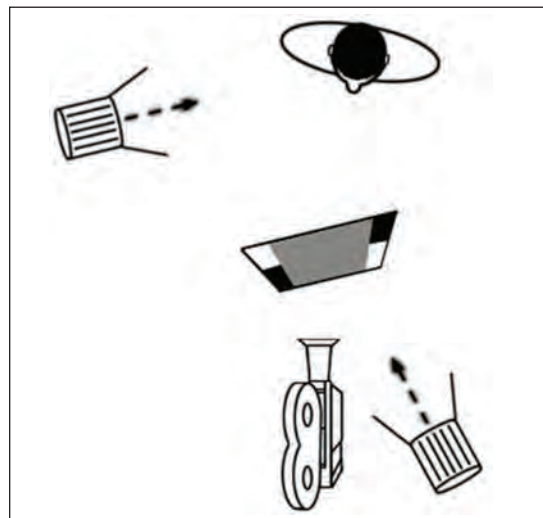

Gray Card Plus used for color correction

When using the Gray Card Plus in scenes where lighting consists of different color temperatures, such as a combination of daylight, fluorescent, or tungsten, you have two options. The first option is to read the color temperature of the various areas of the scene, and determine the color temperature of the area that is visually dominant. The card is then shot in this area to provide a reference for the color correction needed in transfer or print.

There are instances when the lighting doesn't match the film's color balance, such as when shooting under fluorescent lighting or warm, household incandescent lights without correction filters. In those instances:

- Verify that the card receives the same light (color and intensity) as the scene to be shot. If necessary, light the card separately, maintaining the same dominant color balance of the main scene.
- When the shot with the card is graded to a neutral gray, the scene(s) following will be corrected to a more natural looking color balance.

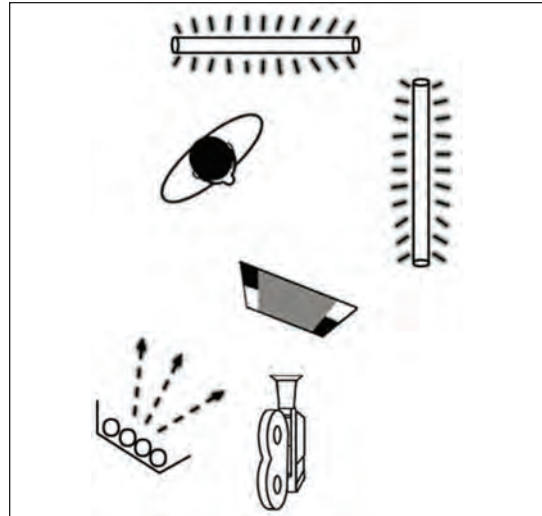

Gray Card Plus used in mixed lighting

The second option is to determine the average color temperature for the scene. Next, light the card for this color temperature using a separate light. When the shot of the card is graded to a neutral gray, the scenes following will be corrected for a warmer or cooler color balance as determined by the light on the card.

When your lighting consists of different color temperatures, such as a combination of daylight, fluorescent, or tungsten:

- Read the color temperature of the various areas of the scene.
- Determine the color temperature of the area which is visually the most dominant or most important. Shoot the card in this area as a reference for the color correction needed in the transfer or print.
- OR, determine the average color temperature in the scene. Light the card for this color temperature using separate lights. A voltage dimmer or color correction gels can be used to achieve the desired color balance on the card.

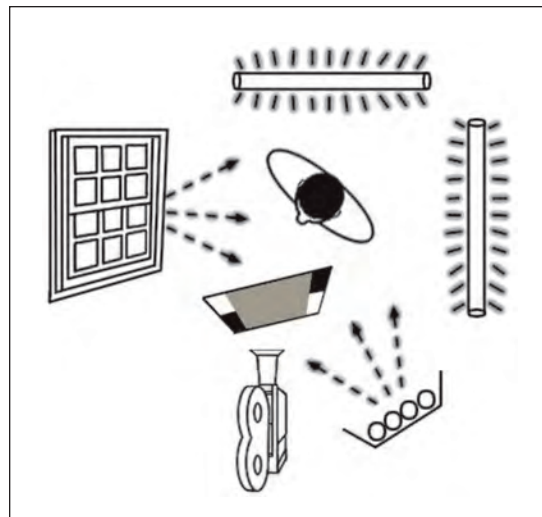

When the shot of the card is graded to a neutral gray, the scene(s) following will be corrected for a warmer or cooler color balance as determined by the light on the card.

Gray Card Plus used to produce lighter or darker grading

The Gray Card Plus is also used when a scene is to be graded or printed lighter or darker for effect, such as when shooting day-for-night scenes at normal exposure, then printing or grading to look like dusk or night. The scene is shot at normal exposure to provide a full-range negative. To darken the scene, the card is overexposed. To lighten the scene, the card is underexposed. The amount the card is over or underexposed provides a grading reference for transferring or printing.

To maintain colored lighting, make sure that you shoot the card under white light (light balanced for the film). This will preserve your creative lighting when the card is timed/graded to a neutral gray.

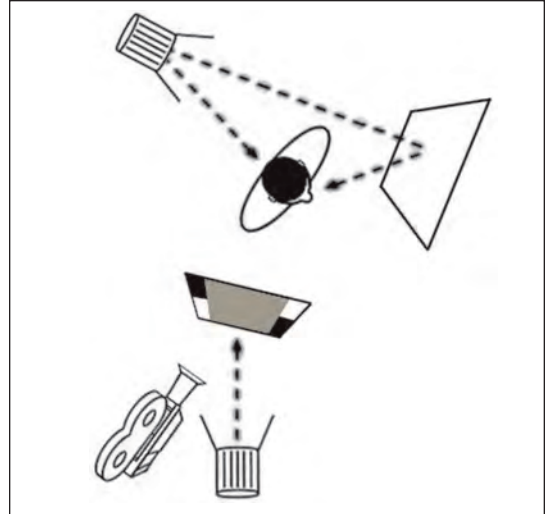

“Cinematography is not something that should be up for grabs. It has to be considered as part of the sensation of experiencing a movie. Comparing film and video now is comparing apples and oranges. It’s chemistry and science. It’s all about how you want people to perceive your movie, and what the audience is going to feel.”

—*Lemore Syvan, Independent Producer*

CAMERA AND LIGHTING FILTERS

A filter is a piece of glass, gelatin, or other transparent material used over the lens or light source to emphasize, eliminate, or change the color, density, or quality of the entire scene or certain elements in the scene.

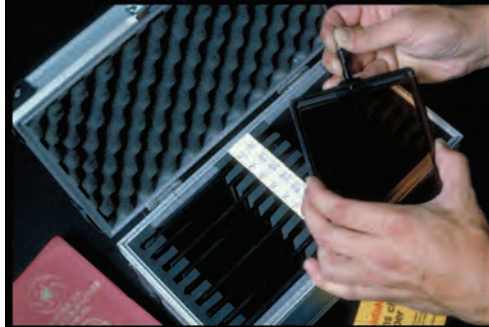

CAMERA FILTERS

Optical filters provide the means to profoundly affect the image you create. They are most often used at the lens during the actual shooting, but can also be physically inserted into telecines and scanners, and can be virtually applied when the image exists in data space.

Filters can be regarded as belonging to one of four general types:

- **Color correction**—broadly, these are filters that affect the daylight/tungsten balance and the green/magenta shift of the light that passes through them. The most common of these is the 85 filter, which corrects daylight to tungsten. This is the filter we use when we shoot a day exterior with tungsten balanced film. There are many grades, colors and densities of this type of filter, designed to allow us to deal with nearly any color of light and make it a color that the film can manage. They are categorized as conversion, light balancing, and color compensating filters.
- **Optical effect**—these filters, like the polarizer, the star filter, or the split field diopter, redirect or selectively refract the light passing through them. The polarizer is commonly used to reduce glare and eliminate reflections. It does this in the same way as do your sunglasses, by allowing only aligned, parallel wavelengths of light to pass through its density. It is especially effective in enhancing the deep blue of the sky.
- **Exposure compensation**—filters that affect the quantity of light passing through with minimal impact to the color or quality. The significant member of this group is Neutral Density. ND filters come in a variety of densities, usually in one-stop increments.
- **Color effect**—these filters selectively apply an overall color bias to the image. Popular choices include tobacco, sepia, and coral. The enhancing filter is a specialized version that intensifies the saturation of only the red tones in the image. Graduated filters, so-called grads, affect a selected portion of the image by manipulating the filter in a rotating matte box. One of the most popular, the sunset grad, applies a warm tone to the top-most part of the image and enhances the warm sky of an actual or contrived sunset without affecting the bottom half of the image.

Note: Proper exposure compensation should be made for each filter placed on the camera lens. Filters absorb part of the light that would normally strike the film, so the exposure must be increased—usually by using a

larger aperture. Filtration is based on the light source and the film type. Film datasheets for KODAK Motion Picture Films note exposure compensation for commonly used filters.

CONVERSION FILTERS

Color motion picture films are balanced in manufacturing for use with either tungsten light sources (3200K) or daylight (5500K). Color conversion filters can be used to match a film and a light source that have different color balances.



To match a daylight balanced film with a tungsten source, use an 80A filter.



To match a tungsten balanced film with a daylight source, use an 85 filter.

These filters are intended for use whenever significant changes in the color temperature of the illumination are required (for example, daylight to artificial light). The filter may be positioned between the light source and other elements of the system or over the camera lens in conventional photographic recording.

Filter Color	Filter Number	Exposure Increase in Stops*	Conversion in Degrees K
Blue	80A	2	3200 to 5500
	80B	1 2/3	3400 to 5500
	80C	1	3800 to 5500
	80D	1/3	4200 to 5500
Amber	85C	1/3	5500 to 3800
	85	2/3	5500 to 3400
	85N3	1 2/3	5500 to 3400
	85N6	2 2/3	5500 to 3400
	85N9	3 2/3	5500 to 3400
	85B	2/3	5500 to 3200

LIGHT-BALANCING FILTERS

Light-balancing filters enable the photographer to make minor adjustments in the color quality of illumination to obtain cooler or warmer color rendering. One of the principal uses for KODAK Light Balancing Filters is where light sources frequently exhibit color temperatures different than that for which a color film is balanced. When using a color temperature meter to determine the color temperature of prevailing light, you can use the table below, which converts the prevailing temperature to either 3200K or 3400K.

Filter Color	Filter Number	Exposure Increase in Stops*	To Obtain 3200K from:	To Obtain 3400K from:
Bluish	82C + 82C	1 1/3	2490K	2610K
	82C + 82B	1 1/3	2570K	2700K
	82C + 82A	1	2650K	2780K
	82C + 82	1	2720K	2870K
	82C	2/3	2800K	2950K
	82B	2/3	2900K	3060K
Yellowish	82A	1/3	3000K	3180K
	82	1/3	3100K	3290K
	81	1/3	3300K	3510K
	81A	1/3	3400K	3630K
	81B	1/3	3500K	3740K
	81C	1/3	3600K	3850K
	81D	2/3	3700K	3970K
	81EF	2/3	3850K	4140K

COLOR COMPENSATING FILTERS FOR COLOR CORRECTION

A color compensation (CC) filter controls light by attenuating principally one or two of the red, blue, or green parts of the spectrum. They can be used singly or in combination to introduce almost any desired color correction. You can use CC filters to make changes in the overall color balance of pictures made with color films, or to compensate for deficiencies in the spectral quality of the light to which color films must sometimes be exposed. Such corrections are often required, for example, in making color prints or in photography with unusual light sources. If the color balance of a test is not satisfactory, you can estimate the extent of filtering required to correct it by viewing the test print through color compensating filters.

Color compensating filters are available in several density values for each of the following colors: cyan, magenta, yellow, red, green, and blue. The density of each color compensating filter is indicated by the number in the filter designation, and the color is indicated by the final letter. In a typical filter designation, CC20Y represents a "color compensating filter with a density of 0.20 that is yellow."

NOMOGRAPH FOR LIGHT SOURCE CONVERSION

This nomograph can be used to find the approximate filter for a particular conversion by placing a straightedge from an original source (T1) to a second source (T2). The appropriate filter can be found on the centerline.

NOMOGRAPH FOR LIGHT SOURCE CONVERSION

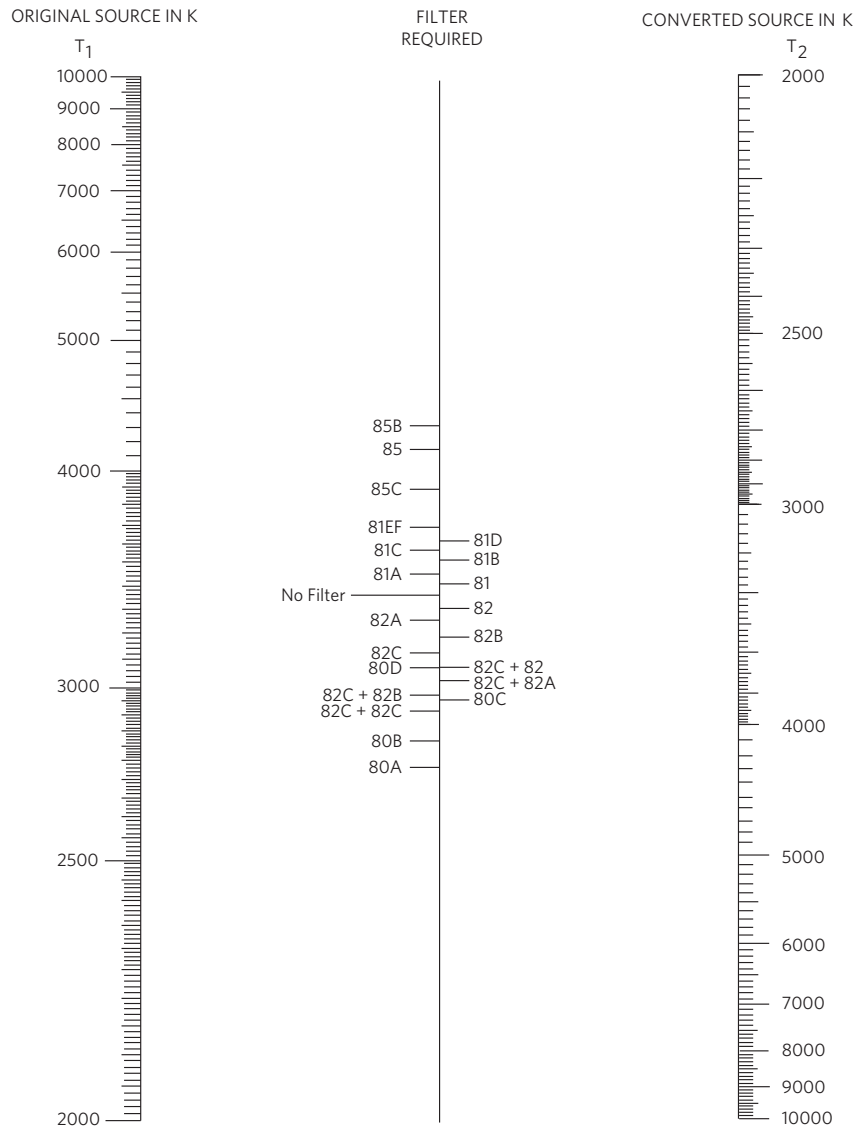

ULTRAVIOLET-ABSORBING AND HAZE-CUTTING FILTERS

Photographs of distant landscapes, mountain views, snow scenes, scenes over water, and sometimes aerial photographs in open shade made on color films balanced for daylight are frequently rendered with a bluish cast. This is caused by the scattering of ultraviolet radiation to which the film is more sensitive than the human eye. A 1A (skylight filter) absorbs ultraviolet light. By placing this filter over the lens, you can reduce the bluish cast and obtain a slight degree of haze penetration.

POLARIZING FILTERS

Polarizing filters (also called polarizing screens) are used to subdue reflections from surfaces such as glass, water, and polished wood, and for controlling the brightness of the sky. The amount of polarized light from a particular area of the sky varies according to the position of the area with respect to the sun, the maximum occurring at an angle of 90° from the sun. Therefore, **avoid panning the camera** with a polarizer because the sky

will become darker or lighter as the camera position changes. The sky may appear lighter than you would expect for these reasons:

- A misty sky does not photograph as dark as a clear blue sky. You can't darken an overcast sky by using a filter.
- The sky is frequently almost white at the horizon and shades to a more intense blue at the zenith. Therefore, the effect of the filter at the horizon is small, but it becomes greater as you aim the camera upward.
- The sky near the sun is less blue than the surrounding sky and, therefore, is less affected by a filter.

When you begin making exposures with a polarizing filter, remember that this filter has a typical filter factor of 4 (increase exposure by 2 stops). This factor applies regardless of how the polarizing filter is rotated.



Without polarizing filter



With polarizing filter

NEUTRAL DENSITY FILTERS

In black-and-white and color photography, filters such as the KODAK WRATTEN Neutral Density Filters No. 96 reduce the intensity of light reaching the film without affecting the tonal rendition in the original scene. In motion-picture work or other photography, neutral density filters allow use of a large aperture to obtain differential focusing. You can use them when filming in bright sunlight or with very fast films without having to use very small lens apertures. This gives you more control over the depth of field in your scene.

Also available are KODAK WRATTEN Gelatin Filters with combinations of neutral density and color conversion filters (for example, No. 85N3 and 85N6). These filters combine the light-conversion characteristics of KODAK WRATTEN Gelatin Filter No. 85 with neutral densities.

Neutral Density	Percent Transmittance	Filter Factor	Exposure Increase in Stops*
0.1	80	1 1/4	1/3
0.2	63	1 1/2	2/3
0.3	50	2	1
0.4	40	2 1/2	1 1/3
0.5	32	3	1 2/3
0.6	25	4	2
0.7	20	5	2 1/3
0.8	16	6	2 2/3
0.9	13	8	3
1.0	10	10	3 1/3
1.0 + 0.1	8	12	3 2/3
1.0 + 0.2	6	16	4
1.0 + 0.3	5	20	4 1/3
1.0 + 0.4	4	24	4 2/3
1.0 + 0.5	3	32	5

*These values are approximate. For critical work, check by accurate tests, especially if you use more than one filter.

ENHANCING FILTERS

Made from “rare earth” elements, these filters absorb or remove certain narrow bands of color in the spectrum, transmitting the adjacent colors. The resulting effect is an intensifying or enhancing of the saturation intensity of the transmitted colors. This is most evident with red—the adjacent muddy brown and orange colors are absorbed, leaving the purer crimson and scarlet reds emphasized, prominent, and exaggerated. Greens are also emphasized, but to a lesser degree.

Enhancing filters are used to emphasize color in a scene, such as fall foliage. They are also useful in bringing out contrast in desert landscapes and aerial panoramas. Skin tones can be affected.

CONVERSION ALTERNATIVES

An orange Coral filter can be used as an alternative to the standard conversion filters, such as an 85 filter. Coral filters are available in a series of gradually increasing saturation—from 1/8 to 8. Each step increases the color temperature correction by approximately 250K. This range of choice allows the cinematographer to make the scene incrementally warmer or cooler—or even to change the color during a scene, either for an effect, or to counteract the naturally changing color of the sunlight. Straw filters are also used for alternative color correction.

CREATIVE COLORS

Color filters can subtly change the look or mood of a scene. Certain colors have become standards. Common warming filters include Tobacco, Antique Suede, and Chocolate. The colors usually come in a range of grades, or degrees of saturation, such as Tobacco 1, 2, and 3. Cooling filters include various shades of blue—tropic blue, sapphire blue, storm blue, and other colors, such as grape.

GRADUATED FILTERS

Exterior shots often include a sky that is much brighter than the land below. Graduated filters are used to balance such exposures—the bottom half is clear, the top has color or a neutral gray. The top part absorbs some of the sky light, darkening the sky and balancing it with the land.

The most common graduated or “grad” filter is neutral density. These darken the sky without affecting the color. They can often make blue sky and clouds visible in a scene that would otherwise be burned out (white) by overexposure.

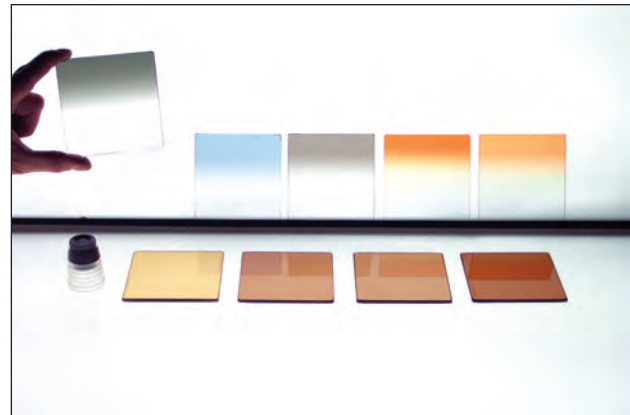

Grad filters are also available in most of the creative colors. Blue grads are often used to enhance the sky in a shot. A blue grad can be positioned over the sky, combined with a tobacco over the desert dunes below, for a saturated, striking effect.

The transitions between the clear and color halves come in three versions: hard, soft, and attenuated. The hard transition makes the full change from clear to full saturation with little or no transition area. This type is used for static scenes divided by a straight line, such as the horizon on the sea. The soft transition has a band in which the color blends smoothly into the clear, allowing the effect to be hidden within the scene. The third type, attenuated, blends density throughout the length of the filter. An attenuator is used for scenes where it’s more difficult to hide the grad effect.

Combination color grads use overlapping bands of several colors to create different effects, such as sunset, twilight, or other unusual effects.

BLACK-AND-WHITE CONTRAST FILTERS

Color filters are used in black-and-white photography to control the contrast of tones in a scene. In color photography, color creates contrast and differentiates subjects of comparable brightness. Without color, equally bright surfaces may blend together. Color filters, which selectively transmit their own color, and absorb the others, can create tonal differences in an otherwise flat scene. A green filter can be used to separate green shrubbery from surrounding brown hills, for example. The shrubbery will appear lighter than the surrounding browns.

Color filters are often used to darken a blue sky captured on black-and-white film. Most panchromatic films have a higher sensitivity to blue than human perception. In a scene with blue sky and clouds, the film may expose the blue sky as brightly as the white clouds, effectively erasing the clouds. By selectively absorbing the blue with a complementary color filter, the sky darkens and the clouds emerge. A yellow filter (KODAK WRATTEN Gelatin Filter No. 8) will emulate human perception. An orange filter will absorb more blue, making a darker sky, and a red filter will have the strongest effect, making some deep blue skies turn black.

OTHER FILTERS

These filters are often used to create various special effects:

A **warming filter** can make a scene more yellow to simulate late afternoon.



Without warming filter



With warming filter

A **soft-focus filter** can give the illusion of another time or soften blemishes on skin.

Special effects filters, to provide color bursts, stars, and otherworldly effects are used to color scenes in ways that never occur in the real world.

LIGHTING FILTERS

Filters are used to modulate the color and quality of light and are available in many colors. Filter swatch books are used to compare and select filters. Printed information is interleaved with the swatches that typically include filter name, product number, percentage of light transmission, and sometimes a spectral transmission graph that demonstrates the colors or portions of the spectrum transmitted and absorbed.

A number of color filters have been developed specifically for motion picture use, and manufacturers usually differentiate between those and traditional theatrical colors. Theatrical colors are more saturated and often called party gels.

Color lighting filters, or gels, include color correction gels and creative color gels. Color correction gels change light's color temperature according to the cinematographer's needs. Film stocks and lighting are balanced for fixed color temperatures. Filters allow manipulation of a scene's color balance—either the entire image or selected areas within the frame. Creative gels range from subtle tints, which only slightly change the hue of a light, to saturated deep colors that can create striking effects.

After extended use, heat and light fade a gel's color, and the gel should be replaced. The closer the gel is mounted to the lamp, the hotter it gets, and the quicker it fades. Mounting a gel further from the lamp, such as in a frame supported by a C-stand, and allowing air ventilation between the lamp and the gel can extend the useful life span of a color gel.

There are also a number of diffusion filters available for lights that affect the quality of the light from the light.

“The new [ARRIFLEX 416 Super 16] camera is a marvel of modern technology. It is lightweight, compact, and quiet, and the viewfinder (based on the ARRI 235) is incredible. I happened to be in Munich, Germany, when ARRI was developing the finder and was invited to test a prototype and give my comments, so it was exciting to see the final product. You can easily judge focus and lighting while the camera is rolling. We used the new 8, 12, 14, and 16 mm prime lenses that are stunningly sharp without flaring.”

—*Christian Sebaldt, ASC, Cinematographer*

LIGHTING

Effective lighting is the essence of cinematography. Often referred to as painting with light, the art requires technical knowledge of film stocks, lighting instruments, color, and diffusion filters, and an understanding of their underlying concepts: exposure, color theory, and optics.

CREATING DIMENSION

The cinematographer must make a two-dimensional image—the frame projected on a screen—appear three-dimensional. Lighting is the primary tool used to perform this “magic.” To create a convincing three-dimensional image, the subjects and layers of the scene must be separated from each other. This is accomplished with light or color, creating contrasts of light against dark or dark against light, and by strategic placement of lights and color elements.

The cinematographer must consider how light falls on and around actors, how colors bounce off objects and reflect onto faces, and where the highlights and shadows are. Several factors influence lighting style: the director’s needs, the story, the budget, the experience and artistic vision of the cinematographer, lenses and lighting equipment, and the film’s sensitivity.

There are two basic lighting philosophies:

- **Naturalism** follows the logical positioning of light sources in a scene and is often referred to as motivated lighting. For example, when two people are photographed facing each other in an exterior daylight scene, and one person is backlit, the other person should be in full sunlight.
- **Pictorialism** allows the use of light angles that violate Naturalism’s logic for artistic effect. Though not realistic, both people might be backlit simply because it looks better.

There are two basic styles of lighting:

- **High-key** lighting is predominantly bright and allows few dark areas or shadows within the scene. This kind of lighting features strong illumination on the subject and often an equally exposed background.
- **Low-key** lighting enhances depth by using contrasting tones of highlights and shadow. Only a few areas are lit at or above key, resulting in more shadow areas. This ratio creates the low-key effect.

THE PROPERTIES OF LIGHT

Any source of light can be described in terms of four unique and independently respective properties:

- **Intensity**—Light can range from intense (sunlight) to subdued (match light). We measure intensity in units called foot-candles, which define the amount of light generated by a candle flame at a distance of one foot. Generally, we discuss different intensities of light in quantified terms of **stops**.
- **Color**—Light has a color balance, or bias, which is dependent on the source (daylight, tungsten, etc.).
- **Quality**—Hardness (directness) or softness (diffuseness) of the light is referred to as quality.

- **Angle**—The angle of the source, relative to the reflective object or subject, affects intensity and quality.

ADDITIVE AND SUBTRACTIVE LIGHT

In exterior daylight settings, we may have too much light filling our subject. To compensate, we often use a technique called **subtractive** lighting. We use negative fill, which is the removal of some of the quantity of light to control shadows of varying densities.

Additive lighting is probably more familiar. When we add light, we often use electric lamps. But we can also use reflectors, bounce boards, and other tools to redirect light so that it falls on the subject. In so doing, we add light.

Cinematographers typically combine the techniques of additive and subtractive lighting in order to control and manipulate a scene's contrast.

CONTRAST AND LIGHTING RATIOS

Like painting, cinema is a two-dimensional representation of three-dimensional subjects. In order to define space and suggest shape, we create different levels of contrast on each subject.

When we introduce a level of contrast, we create the illusion of the third-dimension. That illusion is called **modeling**. The degree to which we execute that modeling is called the **contrast ratio**. We express that ratio in terms of **stops**.

Examples of contrast ratios:



A 2:1 contrast ratio



A 4:1 contrast ratio

The side of the face nearer the light is the **key side**; the light that illuminates it is known as the **key light**. The side of the face away from the light, the dark side, is known as the **fill side**; the light that illuminates it is known as the **fill light**. (See "Three-Point Lighting.")

The difference between the key and the fill, expressed in stops, is the **contrast ratio**. The fill light is always the "1" in the ratio. Conventional contrast ratios are applied to relatively small areas, primarily people. To maintain lighting continuity it can be helpful to express the mood of the shot or sequence in terms of a contrast ratio. A low-key shot has a higher ratio of key-to-fill than a high key shot. In a nighttime shot, for example, the fill light

level can be at least two stops darker than the key light. With a higher ratio, the lighting shows greater contrast. By comparison, in a high-key shot, the fill light level is much closer to the key light level, so a flatter, lower-contrast look results.

To determine the lighting ratio, a light meter reading is taken from the key light side of the subject. This reading is compared to the fill light reading. Thus, the resulting ratio is referred to as key-to-fill.

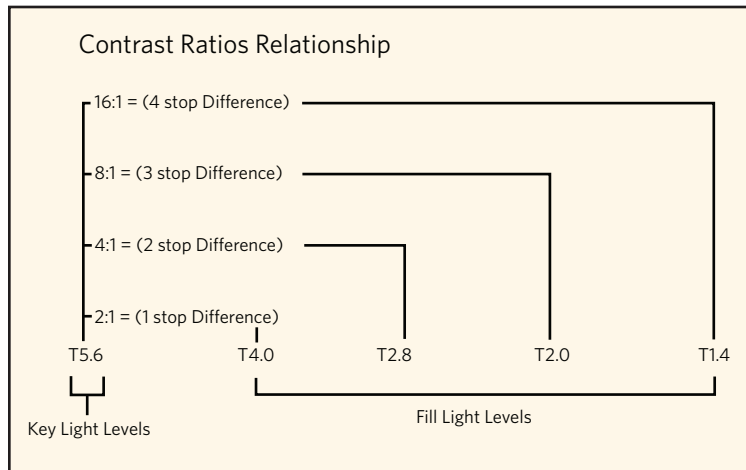

This chart is an example of the relationship between the contrast ratios, camera stops, and T-stop readings.

DIRECT AND INDIRECT LIGHT

Light output from a **direct source** travels in an aligned, focused path. That light is known as **hard light**.



Light output from an **indirect source** travels in a non-aligned, diffuse path. That light is known as **soft light**.



The largest natural source of soft light is our atmosphere. That light is often further softened when it passes through the clouds of an overcast sky. Any time light is broken up, redirected, or diffused, it becomes softer. When we create soft light artificially, we usually bounce a hard source off of an irregular, reflective surface or project the light through a diffusion medium.

Important: A light's relative hardness or softness has nothing to do with the intensity, or quantity, of that light. An overcast day may be dark compared to a sunny day, but there is still a massive quantity of soft light coming through those clouds. A match flame, one of the hardest sources to find, produces only a tiny amount of light.

There are valid applications for both hard and soft light:

- Soft light is flattering to most faces because it creates few shadows and tends to wrap around objects. That same quality makes it less useful for creating modelling and depth definition.
- Hard light creates deep, intense shadows and it is easier to control. The trick is using it appropriately, because it can tend to look fake or "sourcey."

THREE-POINT LIGHTING

While we can describe a light in terms of its properties, we name it based on its function.

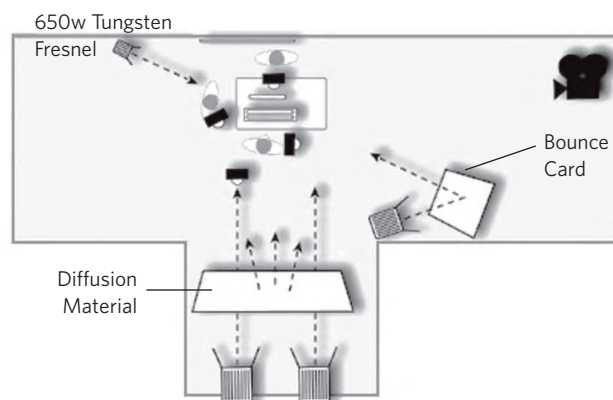

The **key light** is often the main source of illumination in a scene. Its technical purpose is to produce a level of light that will permit proper exposure. The side of the subject nearer the light is the **key side**; the light that illuminates it is known as the **key light**. The side of the subject away from the light, the dark side, is known as the **fill side**; the light that illuminates it is known as the **fill light**.

The **fill light** is the source that illuminates the shadow areas—we “fill in” the shadows. Its technical purpose is to reduce contrast. The side of the subject that is opposite the key is called the **fill side**.

The **back light** is the source that lights the side of the subject opposite the lens. We use a back light to separate the subject from the background and to enhance the feeling of depth.

99.9% of all lights can be described in terms of **property** and **usage**:

Property

Intensity Bright or dim
 Color Daylight or tungsten
 Quality Hard or soft
 Angle Placement relative to subject

Usage

Key Main source of illumination
 Fill Contrast management
 Back Background separator

CONTROLLING LIGHT

So that the cinematographer remains in control of the project’s look—day or night, interior or exterior, a variety of materials are used to diffuse, diminish, soften, and spread light beams. Dense diffusion material generally has greater light scattering properties than less dense material. Reflector board, typically foam core and beadboard, is often positioned to bounce light where needed. Scrim, usually made of metal mesh and mounted to the lights, can be used to reduce the intensity of light. A single scrim cuts the light by half a stop; a double scrim cuts light by a full stop.

When faced with a dark set or practical interior, we start by placing lights and accessories, and attempt complete control over the light levels in the scene. Lights can also be added when shooting outside during the day to gain control. Furthermore, the sun can be blocked, bounced, reflected, or diffused if needed.

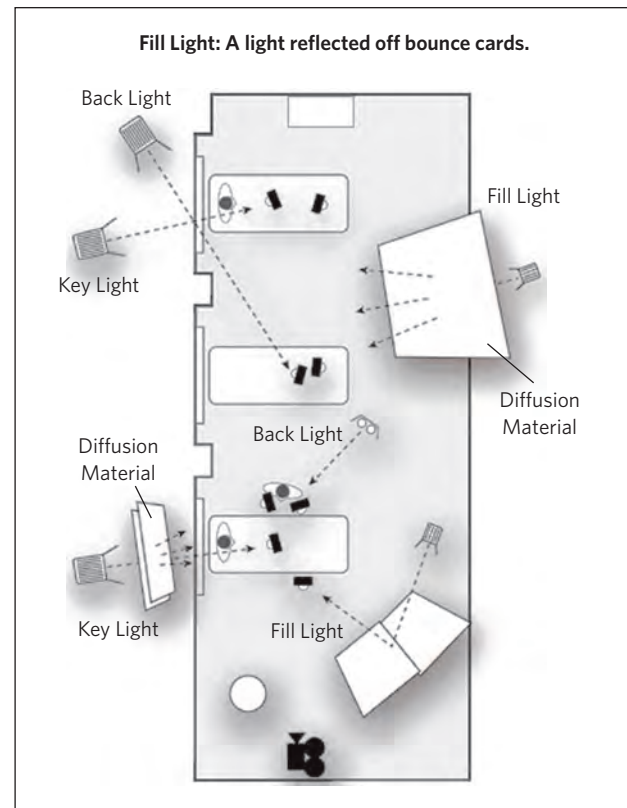

Following are more useful strategies for controlling light:

- Use **lights** to fill shadow areas.
- Filter sunlight with **diffusion**. Diffusion material such as silk or grid cloth can be stretched over a frame and mounted on stands to cast a diffused light over the entire frame. This softens shadows and reduces contrast.
- Use silvered **reflector boards** or white cards to bounce diffused sunlight into the shadows. Alternately, the hard surface of a reflector or mirror can be used to throw a powerful shaft of sunlight into shaded areas.
- Use black material as **negative fill** to create shadows and modeling on subjects otherwise washed out by flat sunlight. This technique is also useful in overcast light to create interest in an otherwise flat, even light.

LIGHT SOURCES

Some of the lights commonly used on motion picture sets are:

PAR (Tungsten and HMI)—Available in various beam spreads from narrow to wide, they allow for selective, controlled subject lighting.

Light Banks—PAR lights mounted in multi-unit configurations, usually from 6-light up to 36-light, light large areas with diffusion—a large soft source.

Beam Projectors—These produce a narrow parallel beam of light that creates a shaft of light and results in sharp shadows.

Ellipsoidal Focus Spots—Popularly referred to by brand name, e.g. Leko or Source Four, these produce a narrow bright beam with a long throw. Ellipsoidal Focus Spots are used as selective lighting to project gobo patterns on backgrounds, shafts of light, and hard shadows. These are most commonly used in theatrical lighting.

LEDs—Mounted in banks, often near the camera, LEDs provide low power, cool light that's used for soft fill.

Tungsten, HMI, and fluorescent refer to lamp types. **Open face** and **fresnel** refer to types of fixtures that hold lamps. PAR lights are very efficient because they use parabolic reflectors. Open face tungsten lights are quartz halogen units without a lens; they are brighter, but harder to control than units with lenses. Open face tungsten lights are primarily used for bouncing and through diffusion.

Barn doors on the light sources control the width of the light. They're used to prevent unwanted shadows or to create shadows where we do want them. They offer greater control in the "flood" position of the lighting unit. Flags, dots, and cookies in a variety of shapes and sizes are used to create shadow patterns. Gelatin filters, or gels, are mounted in front of lights and used to adjust color.



“KLMS [KODAK Look Manager System] was great. I could try out various stocks, look at the grain structure, and see how they handled colors. I also experimented with various filtration packages to see how they reacted to the hard sunlight and deep darkness of Florida. Coming from Seattle, I found the difference between light and shadow almost unbelievable. We knew we would need film’s latitude to capture that distinctive look, and the Super 16 format fit with our budget and the need to move quickly and with a small crew.”

—Benjamin Kasulke, Cinematographer

PROCESSING

The film arrives at the laboratory by a variety of means—hand, courier, air freight—and is generally accompanied with instructions for processing and printing. The usual form for these instructions is the camera sheet, but company orders or letters are also acceptable. In addition to paperwork, the film cans should be labeled and special instructions to the lab should be clearly marked on both the camera sheet and each film can. It is essential to tell the laboratory in writing:

- What you are sending (film type and quantity).
- What processing is required, clearly identifying special instruction.
- What dailies/rush printing is required, if any, and what electronic transfer is needed.
- The name and address of the production company, the contact name, and the telephone number.
- Where to deliver the dailies/rush prints with the contact and phone number at the delivery address.

Below are some of the principal services offered by commercial motion picture laboratories. Few laboratories offer all the services listed but most of them provide a major portion:

- Processing camera film. (Special overnight pickup and delivery, or weekend service is available in some places by pre-arrangement.) Find out what processes are available, including special techniques (for example, flashing, or push/force processing).
- Furnishing advice to help with technical or even aesthetic problems.
- Printing and duplicating from camera films for workprints or release prints. Most laboratories print or duplicate the camera film after it is processed. They may also hold the original in their vault and forward the print for use as a workprint. Thus, the original is protected from damage in handling until it is needed for final conforming.

FILM PROCESSES

Photographic emulsions consist of silver halide crystals suspended in gelatin. When these crystals are exposed to light or other radiation, minute quantities of silver are formed. These quantities of silver record the image. Because they are so small, however, the image can't be seen. This latent (hidden) image requires "amplifying" under controlled conditions to make it visible and "treating" to make it permanent and usable. These steps are known as processing. The following examples of three common processes identify the main stages in each.

The Black-And-White Photographic Process

A **developer** converts the invisible latent image formed during exposure into a visible form by accelerating the action of light in converting the exposed silver halides to metallic silver. To stop the development reaction, the emulsion may be immersed in a **stop bath**—normally an acid solution. Then the **fixer** converts the unexposed silver halides to soluble complexes. The soluble complexes and fixer must be removed from the emulsion by efficient **washing**, otherwise staining and fading of the image may occur. The emulsion is then **dried** under ideal conditions. The emulsion is very soft at this stage and should be handled with extreme care.

Process ECN-2 for KODAK Color Negative Films

First, the **prebath** softens the remjet on the back of color negative films. Then, a **backing removal** step washes away the softened remjet. The **developer** step converts latent image silver halide to silver and dye in the various color layers. The **stop bath** is a highly acidic solution that uniformly and quickly stops the development of silver halide after it has reached the correct level of completion. The stop bath also removes the color-developing agent from the film, preventing it from causing problems later. A **stop wash** prevents acid from contaminating the bleach solution. **Bleach** converts the metallic silver from the silver picture image, formed during color development, to silver-halide compounds that can be removed by the fixer. Then a **bleach wash** prevents bleach from contaminating the fix. The **fixer** converts the silver-halide compounds to soluble silver thiosulfate complex salts that are removed from the film in this fixer and subsequent wash. The **fix wash** removes fixer that could destroy the dye image if not completely removed. The final wet step is the **final rinse**, which contains a wetting agent that prevents drying marks. Finally the film is **dried** in cabinets fed with warm (90° F), filtered air.

Process ECP-2E for KODAK Color Print Films

Some features of this process appear similar to those of ECN-2, but are usually different in practice. The CD2 developing agent, for example, is some ten times more reactive than the CD3 used in the more gentle working ECN-2 process. This agent is used to achieve the correct level of contrast in the projection print while keeping the development time short.

Developer reduces exposed silver halide grains in all three light-sensitive layers. The developing agent is oxidized by the exposed silver halide, and the oxidation product couples with the particular dye coupler incorporated within each layer to produce dye images. A silver image is formed simultaneously at the exposed silver-halide sites. Next, the **stop bath** halts development. The **stop wash** removes excess acid stop to avoid contamination of the next solution. An **accelerator** prepares the metallic silver present for the action of the **persulfate bleach**, which converts the metallic silver from both the sound track image and picture image that was formed during color development, to silver-halide compounds that can be removed by the fixer. In the sound track, the silver image formed during color development is converted to silver halide by the **bleach**. It is then redeveloped to a silver image by a black-and-white **developer** solution. Next, a **wash** removes residual bleach from the film, preventing contamination of the fixer. The **fixer** converts the silver-halide compounds formed in the picture area during bleaching to soluble silver thiosulfate complex salts that are removed from the film in this fixer and subsequent **wash**, which removes unused fixer and the residual soluble silver thiosulfate complex salts formed during fixing. A **final rinse** prepares the film for drying. Finally, the film is **dried**. A **lubrication** step (to promote longer projection life) may be an in- or off-line operation.

Process Control

To ensure the best possible results from a process, the operator checks the physical operation of the machine periodically. A good lab observes the following practices in the physical control of a process:

- Use of correct processing temperatures, which are checked often. Thermometers and temperature-controlling devices are calibrated periodically to insure that the instruments are operating properly. The temperatures of all solutions are kept within specification to ensure tight photographic quality control.
- Use of recommended processing times. Machine speed is checked by carefully measuring the time it takes for a given length of film to pass a specific point. Knowing it is possible to use an incorrect processing time when a machine uses different thread-ups for different film stocks, the careful laboratory checks the solution times every time there is a threading change.

- Use of the recommended replenishment rates. Accurate replenishment replaces ingredients that are depleted and maintains the process at a constant, efficient level. To prevent serious out-of-control situations and chemical waste, laboratories routinely check the accuracy of their replenisher delivery systems.
- An accurate daily record is kept of conditions affecting the process, including developer temperature, amount of film processed, volume of replenisher added, and identification numbers of control strips processed at particular times.
- Regular processing of pre-exposed photographic control strips. The strips are then measured with a densitometer and the results compared with a standard and plotted on a graph. This gives a clear display of the consistency of the process and warnings when it starts to drift, allowing corrective action to be taken.

PROCESSING TECHNIQUES FOR SPECIALIZED FILM LOOKS

Some cinematographers use these alternative techniques to obtain different looks. Popular techniques used to achieve specialized looks are:

- Silver retention techniques
- Push and pull processing
- Cross-processing
- Flashing

Although the impact of using alternate processes varies, in most cases it affects changes occurring in color emulsions, which may not occur equally in all layers. Those changes could result in:

- Improper color reproduction
- Speed shifts
- Contrast changes
- Increased fog
- Increased grain

If you decide to try one of these alternative processes, discuss it with your lab, test the technique in advance, and understand that the results are not reversible.

Silver Retention

Silver retention techniques create a distinguishing visual style. Labs call the technique different names:

- Silver retention
- Bleach bypass
- Skip bleach

In all of these processes, varying amounts of silver are left in the print or negative film stock. And, no matter what it is called, the end results are very similar.

Silver retention may mean:

- Selected bleaching of the silver image
- The film is not bleached at all
- The film is left with varying amounts of silver

Silver retention can happen when developing the negative, intermediate, or print. Each has slightly different looks. To preserve the original camera negative, many filmmakers choose silver retention at the duplicate negative stage. More currently, they achieve the same look in a digital intermediate process.

During the development process, the exposed silver halide is developed and the oxidized developer forms dyes. Those areas contain a silver plus dye image. In the skip bleach process, some of the non-converted silver remains in the film where there is dye formation. This technique produces a certain look, which in some circumstances is very desirable.

Since you will lose color saturation in a silver retention process, it is important to discuss your plan with all necessary departments (props, make-up, costumes, etc.) since dark tones will record as black.

Color negative films that go through a silver retention exhibit:

- Higher contrast
- Less saturation
- Blown-out whites and highlights
- Loss of shadow detail



On the left is KODAK VISION 200T Color Negative Film 5274 that has been processed through the normal ECN-2 process. The colors are vibrant. Green and red are realistically reproduced.



This example of the ECN-2 bleach bypass process shows higher contrast in the woman's face and a lack of detail in the foliage. Also, the colors are very desaturated.



KODAK VISION2 500T Color Negative Film 5218
(exposed with an 85 filter) through a normal ECN-2 process.



The bleach bypass image is higher in contrast
and the colors are very desaturated.

Push and Pull Processing

Push processing compensates for under-exposure (either conscious or accidental), while pull processing compensates for over-exposure (either conscious or accidental).

In push processing, a camera operator shoots film at a higher exposure index (EI) than the film's rating to obtain usable footage under low-light conditions. The lab then compensates for this in the first developer in a reversal process or the developer in a negative process. Pictorially, push processing results in:

- Higher contrast
- Color imbalance (curves are no longer parallel), most notably in the shadows or highlights.
- More grain
- Smoky blue shadows. Because of changes to the yellow record, shadows go smoky in appearance and sometimes actually appear blue.

In pull processing, the negative is under-developed. Overexposure and pull processing are sometimes used to reduce grain and create a special look. Pictorially, the lower contrast makes for a flat-looking image, but with the benefit of less grain. Because there is less saturation, you need to weigh the benefits against the disadvantages.

It is important to consult the lab before under- or over-exposing your film to make sure they offer push and pull processing, and in what increments. Also, they may have advice about how current films react to their adjusted process. In theory, two stops underexposure needs a two-stop push. But in practice, your lab may advise a two-stop push for film underexposed by a stop and a half.



Normal Process

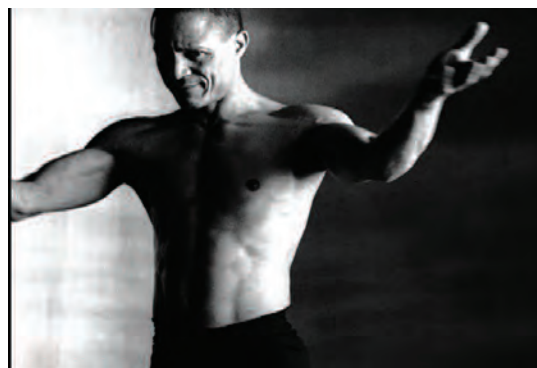

Push-2 Process

Cross-processing

In cross-processing, a film is processed through a process for which it was not intended—for example, running a color reversal film through a camera negative process (ECN-2) instead of through the color reversal process (E-6) for which it was designed.

By processing reversal films through a non-standard process, the actual speed of the film is not known. Therefore, it is strongly recommended that you perform exposure tests to ascertain what the exposure level of the film should be through the lab's process.

Another consequence of using a non-standard process is the impact on color rendition. Therefore, discuss with the laboratory and run tests to make sure that the desired look of the final image is achieved. Use the same lab for all your cross processing—don't switch to someone else and expect to see the same results.



KODAK VISION 250D Color Negative Film 5246, processed normally in ECN-2. Note the uniform contrast and realistic color reproduction.



KODAK EKTACHROME 100D Color Reversal Camera Film, cross-processed in ECN-2. The contrast is higher, and the colors are saturated and distorted.

Flashing

Flashing is a method used to open up shadows. This is accomplished with in-camera methods or in the laboratory. Flashing the negative:

- Lowers contrast and simulates increased toe speed
- Opens filled-in shadow areas that result from silver retention. The toe area of a color negative film is where shadow information is captured.



“We spent years at the National Archives finding incredible footage taken by combat photographers who risked their lives to get the story on film,” Burns says. “We also found film at other archives in the U.S., and in Tokyo, Moscow, Berlin and London. We also found compelling images on 8 mm and some 16 mm movies taken by hobbyists.”

—Ken Burns and Lynn Novick,
Producers, Directors (The War)

KODAK *KEYCODE* NUMBERS TECHNOLOGY

Consider the amount of film that needs to be managed in a typical feature film. At 24 frames a second, 90 feet of film are running through the camera every minute. That's 10,800 feet in a two-hour movie.

Now consider the same movie with a 30:1 ratio (shooting 30 feet for every foot of film that makes it into the finished picture). That's well over a quarter million feet of film! More than five million frames! How do you keep track of all this film and find the exact frame that's needed when it comes time to match the camera negative to the edited workprint?

It's done with human-readable key numbers and machine-readable KEYCODE Numbers. They're printed on the edge of the film when it is perforated—one of the last steps in film manufacturing.

These numbers are exposed as latent images and they become visible after the film is processed. These numbers provide a unique address for every frame of film.

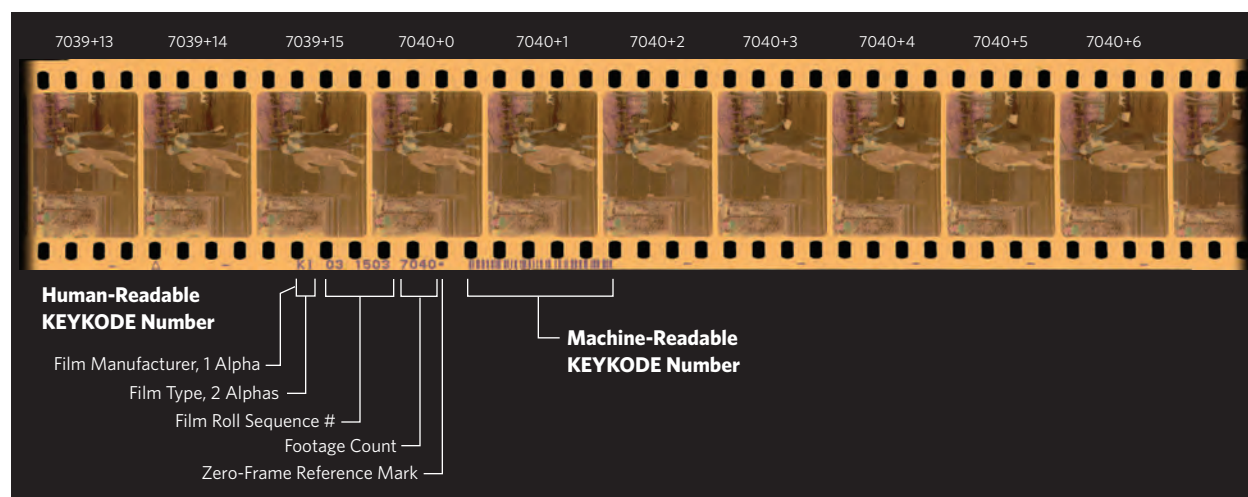

Human-readable key numbers are comprised of five elements:

1. The **manufacturer's code**—K or E for Kodak.
2. The first K or E, with the addition of the second character, identifies the **film identification code**. Each Kodak film has its own set of letters for identification. For example, KI represents KODAK VISION 5246 Film.
3. The key number consists of a six-digit prefix (roll number) and a four-digit footage count. The prefix gives each roll of film a unique identifier. The **prefix number** remains the same while perforating the entire roll. When the roll finishes, the next roll carries a different prefix in increments by 1.
4. The **footage count numbers** increase at precise intervals throughout the roll—every foot for 35 mm film, and every half-foot for 16 mm film. On 65 mm film, the interval is 120 perforations, a little less than two feet. This increment was chosen as the lowest common denominator for the four different 65 mm frame-formats: 5-, 8-, 10-, and 15-perforations.
5. The **zero-frame reference mark**, the dot following the key number, indicates the specific frame of film identified by the human-readable key number and the machine-readable KEYCODE Number. Subsequent frames are identified by their offset—the number of frames they precede or follow the zero-frame. For example, KI 03 1503 7040+06 identifies the sixth frame of film after the zero-frame, KI 03 1503 7040.

KEYCODE Numbers

As mentioned earlier, all the information in the human-readable key number is replicated in the KEYCODE Number—the machine-readable barcode. The following chart shows the barcode detail.



35 mm KEYCODE Numbers

There are also intermediate, mid-foot key numbers along with the full-foot key numbers on 35 mm films. These are useful for identifying very short scenes—those quick cuts where the frames the editor selects may not include a main key number. Key numbers are displayed as large font. Mid-foot key numbers are printed midway (32 perforations) between the main key numbers. The mid-key numbers will be smaller font and contain a (+32), making them easy to recognize as mid-foot numbers.

65 mm KEYCODE Numbers

On 65 mm film, there are two intermediate-key numbers between the key numbers—the first at (+40) perforations, the second at (+80) perforations. They serve the same purpose—to identify very short scenes that may not contain the main key number.

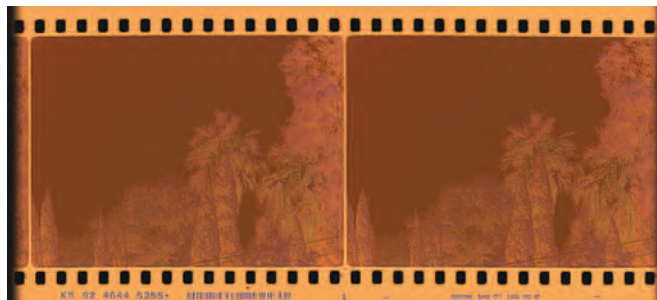

16 mm *KEYCODE* Numbers

Key numbers and *KEYCODE* Numbers on 16 mm, 35 mm and 65 mm films all follow the same format, except that the zero-frame reference dot on 16 mm film is directly above the letter that identifies the film manufacturer, instead of between the key number and the barcode.

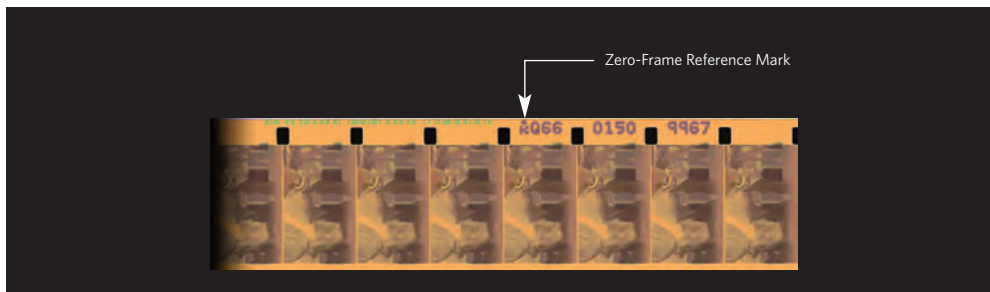

USE OF *KEYCODE* NUMBERS IN NEGATIVE CONFORMING

When a workprint of the camera original is made, the key numbers are printed from the camera film to the workprint, exactly matching the original film. The negative cutter can use these numbers to conform (match) the camera film or the optical intermediate to the edited workprint.

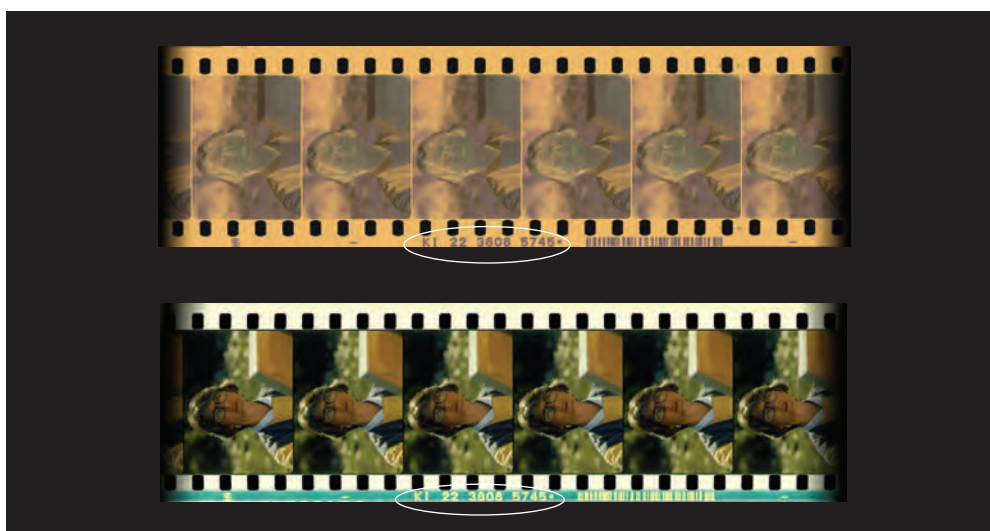

KEYCODE Numbers contain machine-readable barcodes that replicate the human-readable key numbers on the edge of the film. You will notice, when scanned, the film type will display the last two digits of the film code only, not the two digit alpha as visually seen on the film. For example, "K1" represents 5246 35 mm and 65 mm or 7246 for 16 mm. The barcode printout will only read as "46" under the film type.

There is no need to use a loupe or magnifying glass. Sequence and footage numbers, including frame information, are displayed below on a digital readout. But much more important, the output of the reader can be connected directly to a computer to generate a database.



Once the beginning and ending key numbers of each negative roll have been recorded in the database, the cut list will tell the negative cutter precisely where each scene is located within its designated roll. This reduces film handling and saves a lot of search time.

Footages can be indexed from the head or the tail of each roll, further reducing the amount of winding and unwinding needed to locate and pull selected takes for matching.

So far, we've talked mainly about human-readable key numbers and machine-readable KEYCODE Numbers—what they are and the purpose they serve in film editing and negative matching.

KEYCODE Numbers and related technology have had a positive impact on traditional postproduction. More film is now edited and conformed with the aid of KEYCODE readers and computers.

ELECTRONIC POSTPRODUCTION

Where KEYCODE technology has really made an impact is in digital electronic postproduction, such as telecine transfer and nonlinear video editing. It has meant greater efficiencies and more options to release in film or digital or both.

The dotted lines indicate the data paths for KEYCODE Numbers, video and audio time codes and production data. The solid lines are the pathways for video and audio signals.

Film is transferred on a telecine to video dailies for editing. Sound may be transferred at the same time or separately in another session. The KEYCODE Numbers are read from the film with a barcode reader on the telecine and correlated with video time code generated during the transfer. If audio is also transferred, its time code can be correlated as well.

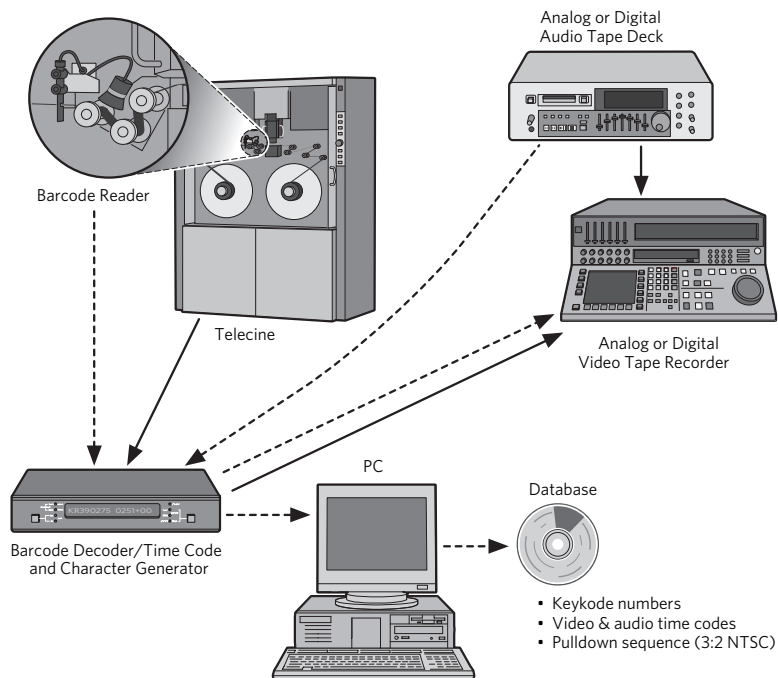

In this system, the barcode decoder/time code and character generator is a multi-task device. Given the input from the barcode reader and the telecine, it correlates KEYCODE Numbers with video and audio time codes and sends this data to the video recorder. It also sends film/video transfer data to a PC. A built-in character generator provides the KEYCODE Numbers and time code burn-in windows for the video dailies.

With this approach, any generic PC can be used to create a comprehensive database. Another popular approach is to combine all the functions of the barcode decoder/time code and character generator into a proprietary PC, thus eliminating a separate piece of equipment.

The feature that makes film origination and electronic post-production such close partners is the relationship between time code and KEYCODE Numbers, and the database that can be easily created when the film is transferred to video. This database will always include these essentials: KEYCODE Numbers, video and audio time codes (if different from one another) and the pulldown sequence—3:2 for NTSC video.

3:2 Pulldown for NTSC

The 3:2 pulldown is used to make up for the difference of frames between the frame rates of film and NTSC video.

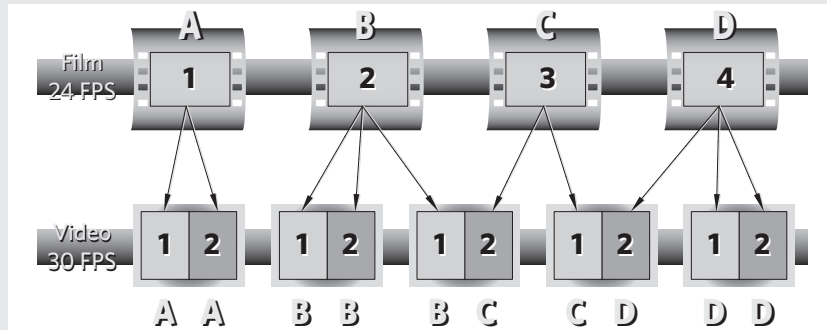

Each frame of video is comprised of two

fields. The electron beams make two passes to produce the complete picture. The first pass scans every other line of video. The second pass fills in the remaining lines. Each scan creates half the picture, 60 times a second in NTSC and 50 times a second in PAL. This type of video display is called "Interlaced." Two interlacing fields make one frame of video.

Beginning on an "A-frame" sequence, the first frame of film is transferred to 2 fields of video—one complete frame. The next frame of film transfers to 3 fields of video—a frame-and-a-half. The third film-frame goes to 2 video fields – the last half of frame 3 and the first half of frame 4. And the fourth frame of film fills 3 fields of video. This is the process by which 30 frames of video are made from 24 frames of film every second.

If we look at the transfer starting on an A-frame (the usual start point), the sequence reads 2:3:2:3 and so on. However, the sequence is generally called 3:2.

Film frames in the transfer sequence are designated A, B, C and D. Starting with an A-frame, people know the frame and field sequence they're dealing with. For instance, a C film-frame is always split between two video frames. If the editor cuts on a B-C video frame, and it isn't flagged, there can be a problem in the cut-list for the negative cutter.

NTSC video editing systems running at 30 fps do not provide film cut lists with better than ± 1 frame accuracy. This is due to the mathematical relationship between 24 and 30 (the 4:5 frame-ratio between film and NTSC video).

Digital nonlinear video editing systems that provide frame-accurate film cut-lists solve the problem this way: they digitize only one field of each video frame and ignore the mixed "B-C" frame. For the video editor, there's now a frame-for-frame relationship between film and video. The negative cutter gets a frame-accurate cut-list from which to conform the negative.

In addition to KEYCODE Numbers, time codes, and the pull-down sequence, the database may also include other useful information. For instance, source-reel information such as camera roll, sound roll, frame rates and transfer rates. Film footage, the script supervisor's production notes, and information for the editor may also be included in the initial database when the film is transferred, or added later during editing.

Providing a comprehensive database gives the greatest value. It could even include contractual agreements about additional use of the footage, all keyed to a single frame by a KEYCODE Number or a time code.

Data can be modified and information added any time—in the editing system or with a personal computer, just as you would with any database.

After the film has been transferred and the sound takes synchronized, the audio and video are digitized for nonlinear editing. The KEYKODE Number/time code database from a floppy disk or other transferable data device, made during telecine transfer, can be loaded into the editing system automatically. This eliminates the need to enter the data manually, saving time and greatly reducing the chance of human error.

The video editing system produces an edit decision list (EDL), and, if the system includes the capability, a film cut list.

The EDL is a list of IN and OUT time codes for all the scenes in the show. It controls the online auto-assembly. This is where the electronic master is recorded with final color correction and final sound.

The source time codes are the IN and OUT edits and the sequence in which all the source material is assembled to record the master. The record time codes are the IN and OUT points for all the edits in the master.

The film cut list is what the negative cutter uses to conform the camera original to a video edit decision list. It indicates the key number and frame offset of the first and last frames for every scene in the film.

Edit Decision List (EDL)				Film Cut List				
Source Time Code		Record Time Code		Clip	Man	Pref	Start	End
04:36:03:00	04:36:25:10	01:00:00:00	01:00:23:10	1	KA74	1893	5342-06	5345+02
04:35:51:25	04:36:03:00	01:00:23:10	01:00:34:15	2	KA74	1893	5346-17	5360+11
04:35:39:20	04:35:51:25	01:00:34:15	01:00:46:20	3	KL66	3248	8344+14	8344+14
04:35:25:15	04:35:39:20	01:00:46:20	01:01:00:25	4	KL66	3248	8345-05	8348+18
04:35:13:25	04:35:25:15	01:01:00:25	01:01:12:15	5	KA74	1893	5364+17	5364+18

To summarize and put it all together:

- Film is transferred on a telecine to a video daily.
- The KEYKODE Numbers are read and correlated with video and audio time codes.
- Sound recordings are synchronized and transferred in the telecine suite, or later in a separate session.
- Key numbers and frame counts are generally burned into the video dailies along with the corresponding time codes. This information can also be recorded in the vertical interval time code (VITC) of the video daily.
- A database, created automatically during the film-to-tape transfer, provides the greatest source of information. It can include a wide variety of production and postproduction data along with the essential KEYKODE Numbers, time codes and transfer specifications. This database can remain with the production throughout its life. It can be copied and distributed as needed. Indexed to a KEYKODE Number or a time code, any note in the database can be referenced to a single frame.
- Entering data automatically into the editing system directly from the transferable data device is simple, fast and accurate—much better than typing all those key numbers by hand.
- The video and audio are digitized for nonlinear editing.

- After editing, a tape of the finished show is recorded, generally with key numbers and time code windows for reference.
- An EDL is produced for the online auto conform, and if the system has the capability, a frame-accurate cut list for conforming the film.

Machine-readable KEYCODE Numbers have brought film origination and electronic postproduction much closer together. Modern film scanners and nonlinear editing systems combine the strengths of both media.

"... Resolution and contrast of video can't deliver that classic feeling. If you do big wide open shots, you feel you have an extreme loss of quality... film holds every detail and is beautiful."

—*Oliver Bokelberg, Cinematographer*

OPTICAL WORKFLOW

The traditional film process can be described as an optical workflow—the process that existed before digital technology. Film was replicated and special effects were created optically.

In a traditional film process, camera negative film is processed and printed so the production company can view the unedited film footage, or dailies/rushes. Today, dailies are more typically viewed electronically, thanks to telecine technology. Faster scanning technology has allowed film-to-digital transfer much earlier in the process, and that is discussed in the Digital Workflow section of this book.

Whether your dailies/rushes are film or electronic, two types are available:

- **One-light dailies** are the most common type, made using the laboratory standard or average printing light. One-light dailies assume the negative is correctly exposed.
- **Timed or graded dailies** are assessed and sent for printing with appropriate printer lights for each camera roll. Not every shot or take in the roll is timed, as would be the case when timing a cut negative to make an approval print. Instead, an average light for that particular camera roll is timed. During timing, the timer typically improves the odd rogue shot in a roll.

With film dailies/rushes, you must select a printing machine exposure that produces an acceptable image. Before timing can take place, however, the rolls of negative must be:

- Logged for identification of shots and takes that may be needed later.
- Cued to activate the printer exposure change.
- Made into roll sizes that are suitable for printing.

Cueing the Negatives

A cue tells the printing machine exactly where to make printer light changes, or fades, during printing. When printing cut negatives, they must be frame accurate. Three methods are used, the first two having been largely superseded by the third. They are:

- Notch Cues
- RF Cues
- Frame count cues (FCC)

After color timing, the film is printed. Different printing methods are used for different purposes:

- **Contact Printing** is the most common type. The original negative and the raw stock are printed in contact with each other, emulsion to emulsion. Contact printing produces a 1:1 transfer of the image size, and the printed image is a mirror image of the original.

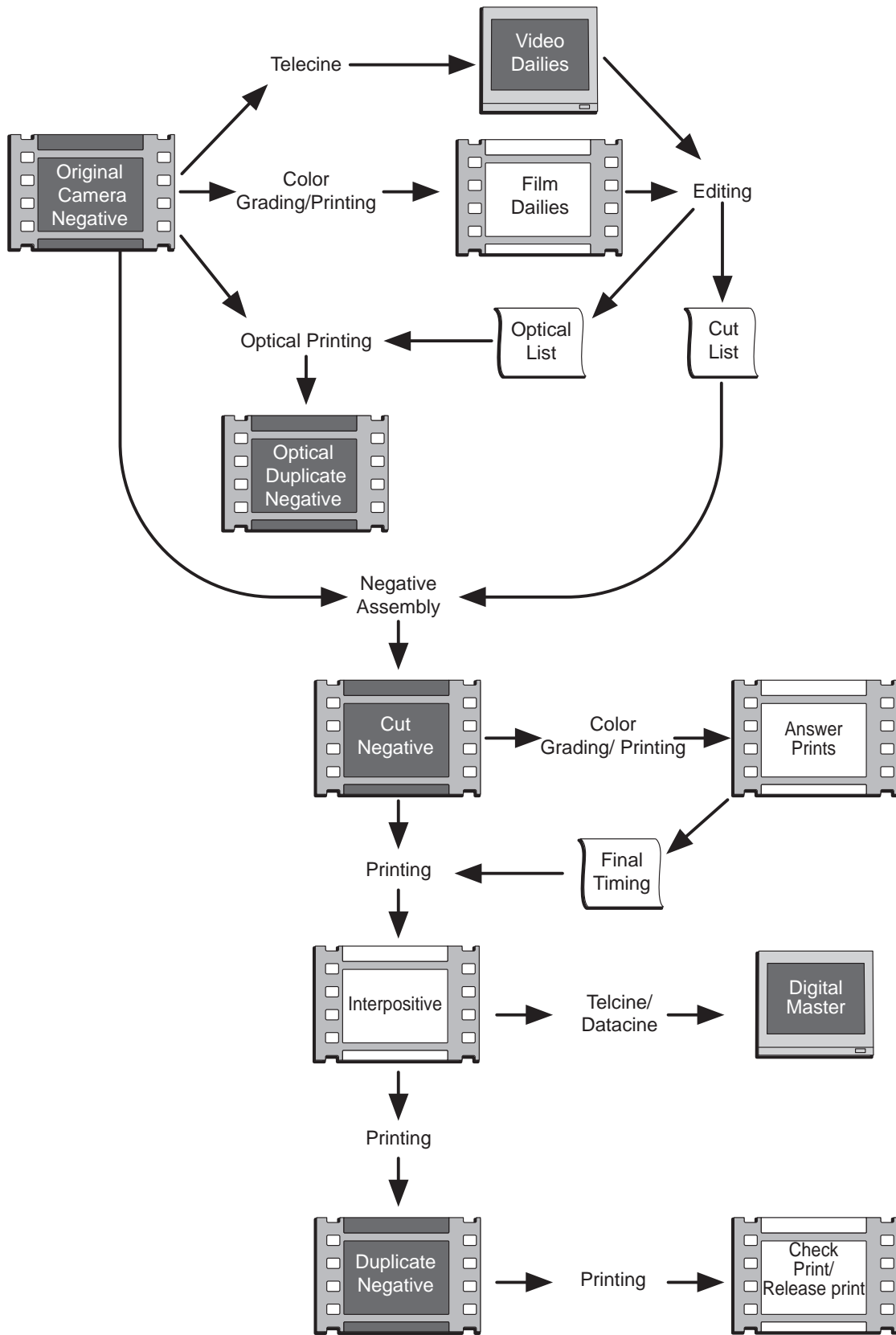

- **Optical Printing** projects the original image, which is rephotographed in a camera through a copy lens. Optical printing lets you change the image size. Additionally, you can print base side of the original to the emulsion side of the printing stock, which produces the same image configuration as the original. This is useful when inserting a copy into an original negative.
- **Rotary or Continuous Printing** allows a printing sprocket to transport the film at a constant speed across a printing aperture, through which the exposing light beam passes.
- **Intermittent Printing** exposes the film frame by frame while stationary in the printing gate. Intermittent movement of a shutter and register pin is used to position, expose, and pull down the film after each frame of exposure in exactly the same way as a motion picture film camera exposes original film.

Commonly used printers are:

- **Rotary Contact Printers** are used for printing rushes, answer prints, show prints, and release prints.
- **Intermittent Optical Printers** are used for printing titles, special effects work, and for changing image size by blowing up or reducing the image.

VIDEO DAILIES

Video dailies/rushes are an alternative to traditional film dailies, and they're preferred when the film is intended exclusively for television production or electronic projection. Rather than physically editing the original camera negative immediately following processing, the film is scanned using an electronic imaging device. Telecine or datacine scanners are designed to suit the needs of the lab facility.

VIDEO DAILIES/RUSHES VERSUS FILM DAILIES FOR THEATRICAL RELEASE

There are advantages and disadvantages to each of these techniques. Basic video dailies/rushes with limited image corrections are generally less expensive than film print dailies. However, the apparent cost savings of video must be weighed against the limitations of the video system in evaluating the images on the monitor. It is often difficult to determine accurate focus and exposure of the negative, for example, and these factors will be very apparent in the final image on a theater screen. Sometimes these problems are not noticeable to the filmmaker until the film footage is cut and printed for release.

Some theatrical releases request both film and video dailies/rushes. The prints are evaluated for scene content and projection quality while the video recordings are sent to the editors. This method provides materials for expedient electronic editing while assuring the director and cinematographer that their negative is suitable.

VIEWING

After processing, the print is checked by the dailies/rushes department to report to the production company the condition of the material, the quality of the images, and, if required, the quality of the action and sound. Problems that might necessitate retakes are identified before the set is broken or moved to a new location.

After viewing and completing the laboratory report, the print and a written report are sent to the editor. The crew assesses the report before the print is dispatched. The laboratory stores the negative until it is needed for negative cutting after the dailies are edited. The negative is also available to the laboratory for use in making rush reprints of selected rolls or takes for the editor.

EDITING

The editor receives the film or video dailies and makes the cut. Modern productions use a non-linear digital editing system to keep track of the shots used.

OPTICALS

Some shots and effects must be created as the editor is working. These are called opticals because traditionally they were made on an optical printer. The editor makes an optical list, or layout, and notes KEYCODE Numbers that match the negative.

Some examples of opticals are:

- Transitions, such as fades (for single strand negative) or wipes
- Reverse motion
- Composite shots (such as a blue screen)
- Titles over picture

Today, opticals are usually created digitally, even when the film is not following a digital intermediate workflow.

Sound Tracks

Traditional sound recording methods, mixing, and playback have been largely replaced by digital technology, offering significant improvements in audio quality and creative flexibility—and automating much of the process.

In addition to conventional analog photographic audio soundtracks, most 35 mm release prints use one or more types of digital audio sound to enhance the theatrical experience.

Commercial film laboratories and audio post-production studios are equipped with recorders to create the type of sound tracks ordered by the production company for release.

NEGATIVE CUTTING

Once edited, the final cutting copy of the original film is returned to the laboratory for negative cutting. Often, an edited video copy with a negative cut list is made. The negatives are then assembled and spliced per the editor's directions.

Splicing Techniques

Cut negatives must be spliced together into the desired sequence. There are three techniques commonly used:

Tape joins—Films are butted together and clear polyester tape is applied across the join, back and front. This type of join is used for joining prints together, and for editing work.

Cement joins—Films to be joined are cut with a common overlap. The emulsion is scraped from one overlap to reveal the film base underneath and film cement is applied. Cement joins result in a clean, permanent join that won't stretch.

Heat Weld (Ultrasonic) Splice—Heat weld splices result in strong permanent joins, which don't stretch. They're not as clean as good cement joins, however, and they're less suitable for acetate base films. Heat weld splices are used for polyester base films, which cannot be joined with film cement.



NEGATIVE CUTTING TECHNIQUES

Cutting 16 mm film

16 mm negatives are normally cut as A and B rolls. This involves successive shots being cut alternatively into the A roll negative and the B roll negative. An opaque black leader is joined between the shots on each roll to match exactly the length of the shots in the opposite roll. The layout of a typical A and B roll after negative cutting looks like this:

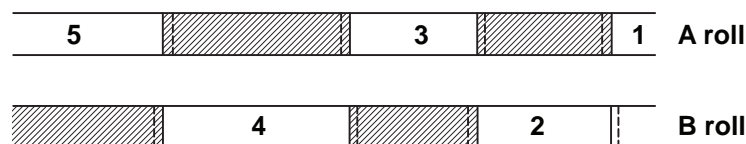

This negative cutting technique is known as Checkerboard cutting. It's used to conceal the overlap cement splice at each join, which, in the case of 16 mm film with its very narrow frameline, would normally encroach into the picture area. The opaque leader hides the overlap of the splice so that when the join is made, the emulsion is scraped in the picture overlap area beyond the last frame of required picture. The opaque leader, which is not scraped, is laid over the scraped picture up to the frame line and conceals the join during printing.

A print is made in two passes on a printing machine; the A and B roll are printed in succession onto one roll of stock. When negatives are cut and printed as A and B rolls, it is possible to incorporate fades and dissolves by

overlapping scenes on the two rolls and closing or opening a fader on the printing machine at the appropriate time.

NOTE:

- Permitted fade lengths are 16, 24, 32, 48, 64, 96 frames.
- A fade-to-black is achieved by dissolving to clear base.
- A minimum of 6 frames should be allowed between the end of one fader movement and the start of the next, to allow the mechanism to reset.

Cutting 35 mm film

Because the frameline on conventional 35 mm film is much wider than on 16 mm film, it is possible to make overlap cement joins that do not encroach into the picture area; hence 35 mm negatives are normally straight cut in a single roll with A and B rolls used only when fades or dissolves are required (A and B for opticals only).

Cueing and Timing/Grading

Cut negatives must be prepared for printing. During this process, each scene is individually timed and its cue points are identified to tell the printing machine where each scene change occurs and therefore each timing change.

This operation is similar to cueing the dailies/rushes, but every shot and event (fades/dissolves) is cued prior to timing.

Cleaning

Before printing, cut negatives are cleaned in an ultrasonic film cleaner to remove traces of dust and dirt that would appear as white sparkle on the final copy print. Cleaning is essential due to handling during cutting, cueing and grading/timing.

Answer Prints

Answer Prints are made from the cut negative after the final cut and after all titles and effects have been added. The laboratory timer in consultation with the director, cinematographer, producer, and/or editor finely times them for color and density. The timing for the answer print is used to make the interpositive, also called IP or Master Positive.

Duplication

After the production company approves an answer print, a master positive, or an interpositive is made. From the interpositive, several duplicate negatives, or internegatives, are made. The final release prints are printed from the duplicate negatives.

- Using duplicate negatives to make release prints protects the original negative from the wear and tear of multiple printing, and provides insurance against damage.

- Multiple language versions, different length or format versions, and simultaneous worldwide release of films all require the existence of duplicate negatives that move between laboratories around the world.
- Scene-to-scene corrections incorporated into a duplicate negative mean it can be one-light printed at high speed. Polyester base duplicate negatives may be used for extra strength when using high printing speeds.

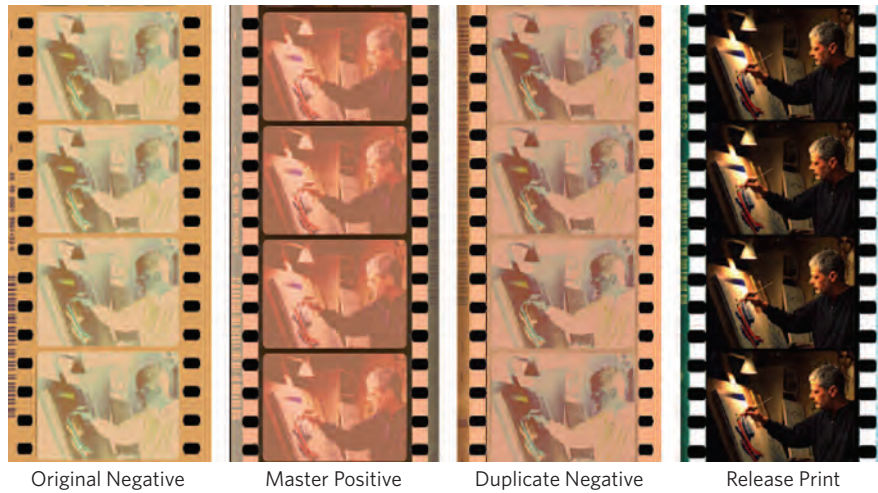

The interpositive is also often scanned or telecined to create the video master for home distribution.

Check Prints

Check Prints are made from the duplicate negative; they are used to assess the quality of the bulk release work.

Release Prints

Release Prints are produced in large numbers at high speeds for theaters around the world.

“Due to budget restrictions, so far we haven’t been able to go with proper 2K scan and realize the full image quality that was captured on the Super 16 negative. But once we have a distribution deal, we will be able to go back to the negative and access the full richness of the images.”

—*Alessandra Piccione, Writer - Producer*

DIGITAL WORKFLOW

A new paradigm is taking shape in filmmaking—a significant shift from the use of just film, or analog tools, to the use of digital tools—allowing filmmakers everywhere to explore creative options with great success and relative ease. The post-production phase of filmmaking has changed significantly with the advent of the digital intermediate (DI) process. The traditional workflow has been completely transformed through advancements in film scanning and computer technology. Digital processes in post-production are replacing traditional photochemical steps such as negative cutting, color timing, printing, and optical effects.

Here is an example of a simplified digital workflow: convert your film footage to video using the telecine process to professional formats like 3/4, Beta SP, Digital Beta, HD, and DVCAM and store the video files on your computer.

Convert telecine dailies from 29.97 to 24 fps using the reverse telecine feature. This allows the editor to edit at true 24 fps, establishing a one-to-one correspondence between the video frames and the film frames. You can edit your project quickly and easily using the real-time architecture and non-destructive editing features of a software program like APPLE Final Cut Pro.

When editing is finished a film cut list is created to conform the original camera negative. This allows the negative cutter to use the film list and the edited video as a guide to conform the original negative to match the edited digital project. Release prints are created from the conformed negative.

DIGITAL INTERMEDIATE

With the wide array of digital post-production techniques and tools available, it is best to assemble your post-production team before you shoot. Their ideas, presented early in the filmmaking process, provide valuable insight, influence various aspects of your production, and help you price out options. A post house can review your project and provide a breakdown of post-production costs, and can also help establish the best workflow.

What is a Digital Intermediate?

The three main stages in the DI process are:

- **Input:** During the input stage, or acquisition, the processed camera negative is scanned using a high-resolution film scanner. The scanner digitizes each frame of film and converts the film images to a series of digital files.
- **Image Processing:** Once the film has been scanned, conforming, color correction, creation of special looks, and addition of special effects are all performed digitally in the image processing stage.
- **Output:** The edited digital files are used to render a digital master, which is recorded out to film using a film recorder or used to render a variety of electronic formats.



The term digital intermediate (DI) is often misunderstood. A digital intermediate is simply a project in its digital state during the image processing stage. Digital Intermediate, therefore, refers to the digital data's transitional nature—a state between the input stage and final delivery.

Traditional Lab and DI Comparison

The digital intermediate process can encompass the whole post-production stage of filmmaking. It can replace a lab and optical finishing workflow by using digital processes to conform, integrate effects, color grade, and prepare the project for final delivery.

Conforming

In a lab and optical finishing workflow, the negative cutter uses a film cut list or an edit decision list (EDL) to cut the original camera negative, place shots in the edited order, and splice them together to produce a conformed negative.

In a digital post-production workflow, negative cutting is eliminated. Rolls of original camera negative are delivered to the post-production house, and only the select shots in the final edit are scanned. Once scanning is complete, the EDL is used to auto-conform the digital intermediate. In this process, the original camera negative is scanned only once and remains intact.

Visual Effects

In a lab and optical finishing workflow, computer-generated effects shots are printed to film, then cut, and matched with the rest of the film frames. Other effects or transitions, such as fades and cross dissolves, are produced optically during the printing process.

In digital post-production, complex effects are created at a computer workstation and are seamlessly integrated with the rest of the files in the digital intermediate. All transitions, such as fades and cross dissolves, are also produced digitally. The duration of transitions can easily be changed and reviewed almost instantly.

Color Timing/Color Correction

In a lab and optical finishing workflow, the color timer uses a color analyzer to look at and adjust the colors of every scene in the movie. The color timer can perform only primary color correction by adjusting the overall color balance of the three primary colors: red, green, and blue. Usually, a number of answer prints are made to view results and gain full approval of color timing adjustments.

In a digital post-production workflow, a colorist performs primary and secondary color correction digitally. In secondary color correction, specific colors and objects in the scene can be selected and manipulated without

affecting the overall color balance of the scene. Adjustments can be tested and viewed in real time. Digital color correction, applied to an entire film, has given filmmakers great creative control and flexibility.

Output

In a traditional lab and optical finishing workflow, the finished film goes through the printing process to create release prints. After timing for color and density is approved, a master positive is printed from the original negative by exposing it onto color intermediate film. All color-timing corrections approved by the filmmaker are applied during the printing of the master positive. Next, the master positive is printed onto intermediate film a second time to create one or more duplicate negatives. Then release prints are made from the duplicate negative. For finished films exhibited in theaters, the master positive is usually used for transfer to electronic formats.

In digital post-production, the final digital intermediate is used to render a digital master. The digital master is recorded directly out to film to create prints or an internegative for release printing or to output a variety of electronic formats including digital cinema, SD, HD, and DVD.

Benefits of DI

The Digital Intermediate process offers flexibility and creative control. The DI process allows digital color grading, visual effects, and digital mastering in a collaborative and interactive environment.

The DI process is also format independent—you can input various formats including film, video, digital media, and computer-generated material. Then, after image processing, any number of formats can be created from the digital intermediate. Therefore, a project captured on film can be output to any number of electronic formats. A project captured electronically can be output to film, although quality can be compromised. Or a project can contain any number of sources. Filmmakers use the DI process to mix media and experiment with different sources.



DI Process is Non-linear

The digital intermediate is a series of digital files that can be sorted, indexed, tagged, viewed, and manipulated in any order. This lets you jump to any point in the project and work in any order. You can also change the order of scenes or instantly view any two shots in the production to check visual continuity.

Full Editorial Control

The digital intermediate process allows the filmmaker to have full editorial control, including the ability to:

- Auto-conform from an updated EDL
- Make manual edits to the DI by duplicating, moving, replacing, or removing frames
- Adjust the timing of cuts and transitions

This level of flexibility makes last-minute changes possible and reduces the costs incurred in a traditional, post-production workflow.

Digital Color Grading

The ability to apply digital color grading provides you with unprecedented control over your work, such as:

- Creating a look or mood
- Manipulating individual colors and objects in a scene
- Painting, retouching, and fixing images
- Emulating lighting
- Emulating camera filters and lab processing techniques

Computer-generated Effects

The digital intermediate process provides better interchangeability with computer-generated material. Effects shots can be fed into the digital intermediate pipeline at various stages for feedback and approval. When finished, the files containing special effects are color-graded and integrated into the digital intermediate.

Visual Effects and Transitions

In a digital post-production workflow, many traditional optical effects can be completed digitally. Some include:

- Transitions such as wipes, fades, and dissolves
- Cropping, resizing, and repositioning of images
- Freeze-frames
- Titles and text

Image Restoration and Repair

There are also many techniques to repair imperfections that include:

- Scratch and dust removal
- Digital painting and retouching

- Image sharpening and blurring
- Reduction or increase in grain

Instant Feedback

The DI environment is interactive and provides the ability to view changes as they are made. One example is digital color grading. The colorist and filmmaker can adjust the colors and view the changes instantly on an electronic display. Instant feedback gives filmmakers more freedom to collaborate, experiment, and respond immediately to changes.

Preserve the Original Camera Negative

The digital intermediate process also helps protect the original camera negative. The negative has to be scanned only once, and then the project files are conformed digitally. The intact, uncut original camera negative can be archived.

Post House Contacts

It is important to know the contacts in a post-production facility and establish clear communication.

Account Executive/Bidding Producer

The account executive (AE) is responsible for your project's contract and financial arrangements for the duration of your project. Initially, the AE provides bid information in collaboration with a post-production supervisor and/or digital effects supervisor.

Producer/Scheduler

The producer or scheduler is your main contact within the post-production facility. The producer's responsibilities include scheduling sessions, scheduling equipment, obtaining receivables, tracking elements in the facility, and delivering the final product.

Post-production Supervisor/Digital Effects Supervisor

The post-production supervisor or digital effects supervisor works on the production team and is your liaison to the post-production facility. The post-production supervisor attends and supervises editing and color timing sessions, and also approves all of the work done at the facility.

Editor

Working closely with the director and producer, the editor executes the EDL. The editor joins shots and scenes into a continuous narrative by using cuts, dissolves, and effects. The success or failure of a production may rely on the quality of the editor's work. If the editing work is good, it's invisible to the audience. If it's bad, it detracts from the story.

Colorist

Colorists are artists who work closely with you to color-correct the film. They are responsible for helping you achieve the overall Look. Colorists help establish continuity between shots and make color decisions that support the story.

INPUT

All digital intermediate workflows begin with acquisition of media in the input stage. As we learned earlier, media can come from different sources such as film, electronic capture, or computer-generated imagery. All source media must be either transferred or digitized.

- **Data Transfer:** If the source media is in a digital format, such as digital video or computer-generated material, it is transferred to storage in the digital intermediate pipeline. Data transfer may involve copying digital image files from one drive to another, or could require a transcoding process that converts a data stream from one digital format to another. Data is reinterpreted during transcoding, so some degradation may occur.

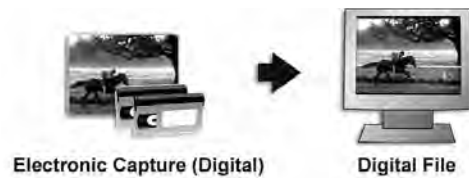

- **Digitization:** Analog source material must be digitized. A film scanner digitizes information from the original camera negative by sampling it at regular intervals and then encoding it. When film is scanned, therefore, the resulting digital image is only a sampling of the image information found in the film negative.

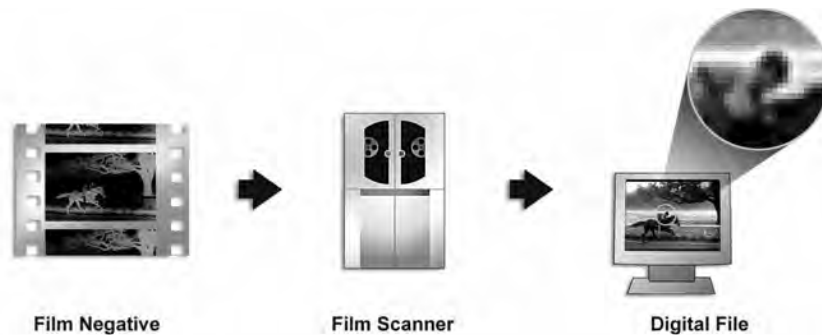

Film Scanning

Selected scenes are converted from film to digital data with a film scanner. Film scanners sample and digitize image information from the original camera negative to create digital image files.

Scan resolution refers to the amount of information sampled and digitized from each film frame. Higher resolution images offer better image quality and flexibility throughout the entire digital post-production process.

Film Scanners

Today's motion picture film scanners deliver excellent image quality. High-end film scanners digitize each frame at a high resolution. When the digital image files are written back to film, the result is not readily distinguishable from the original. Scanning is accomplished by illuminating the original camera negative with a bright light source. For each sample point along a scan line, a charged coupler device (CCD) measures the level of transmittance for red, green, and blue light. This process is repeated a line at a time until the complete film frame is scanned. A digital image file is created that stores color information in three separate channels for red, green, and blue. Each film frame yields a separate digital image file.

Both devices convert analog film to a digital image, but there are major differences. A telecine is used to convert film images to video. They have continuous motion and operate at a high speed. Some telecines have the ability to emulate a film scanner and produce data files. A telecine may require images to be upsampled, depending on the workflow and demands of the project.

While telecine machines output a video signal, a film scanner outputs digital data files. High-resolution film scanning is for a data-centric workflow. Film scanners are often pin-registered, intermittent, and slower than telecines. At the time of acquisition, few adjustments are made to the images. The image files are typically stored on a hard disk for manipulation and digital color grading later in post-production. Film scanners capture more resolution than telecine machines and deliver higher quality images.

RGB Color Space

A color space is the range of colors a system is able to reproduce. A large percentage of the visible spectrum can be represented in the RGB color space by mixing red, green, and blue light in various intensities.

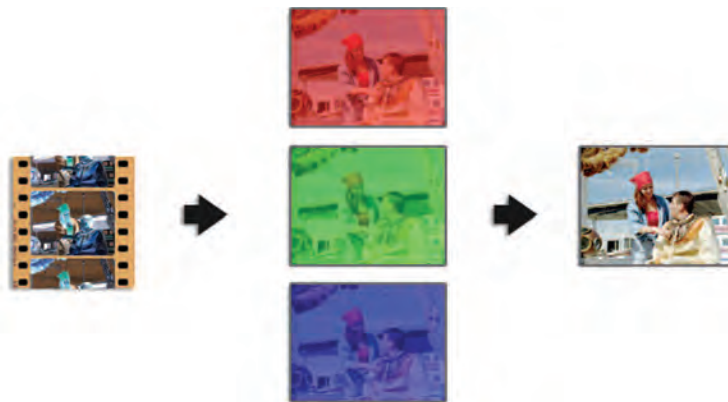

Digital image files use the RGB color space by mixing red, green, and blue to form a color image. Digital intermediate work is typically done in the RGB color space. It is the most common way of viewing and working with digital images on a computer screen.

Color Channels

An RGB image is comprised of three different color channels: red, green, and blue. All three channels are combined to form a color image. Each channel acts as a layer that stores tonal information. When we view channels separately, they appear as gray scale images because each pixel in a channel is actually an intensity value.

The bit depth of the file determines the amount of values possible for each channel. In a 10-bit depth there are 1024 possible intensity values for each color channel. Each pixel in the red channel, for instance, is a discrete intensity value of red from 0 to 1023.



Scan Resolution

Before scanning, scan resolution must be determined. Scan resolution is the sampling rate, or how much information from the original camera negative will be digitized. Once a scan resolution is determined, the original camera negative is sampled at regular intervals. With a lower resolution setting, the sample points are farther apart, which eliminates more original image information. With a higher resolution setting, the sample points are closer together. Thus more original image information is captured. The higher the sampling rate or resolution, the more accurate the digital representation of the original film image.

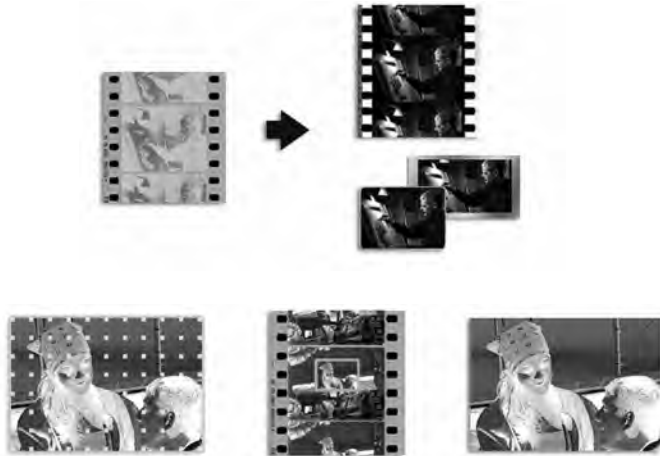

Scan Resolution Considerations

Higher resolution images withstand image processing better because more detail and image information is present. Some considerations when deciding on scan resolution are:

- **The principal output medium:** If your principal output is film for theatrical release, you must scan at a high enough resolution. Scanning at a high resolution provides enough detail when the digital images are recorded back to film. If your principal output is SD or DVD, you can scan the source images at a lower resolution. Choose a resolution that provides the quality for the principal output medium.
- **The look of the production:** Another important consideration is the look you want to achieve during the image processing stage. There is no loss in quality when digital files are simply accessed and copied. The same is not true when files are manipulated—color grading and compositing are destructive to the original image information and can cause digital artifacts.
- **Budget:** Acquiring and working with high-resolution images can be expensive. Typically, images high in resolution provide better quality, but are also large in file size. Larger files take longer to access, manipulate, save, copy, move, and store. A digital intermediate workflow must balance file size, level of image quality, processing speed, and all associated costs.

The most popular scan resolutions for digital intermediate work are 2K and 4K (K represents thousands of pixels across the frame width). A 2K image is 2048 pixels wide, and has become the industry standard for digital intermediate work. A 4K image is 4096 pixels wide and is used when a large amount of detail is needed, such as special effects shots.

The 4K scan contains more detail than a 2K scan—it's also a larger file size at 48 MB per digital image file. A 2K-image file is about 12 MB. You would assume that a 4K file would be double the file size of a 2K file, but it's not.

The 4K file quadruples the necessary storage and bandwidth requirements because it contains four times as many pixels. Images are 2 dimensional, so doubling the two dimensions produces a file quadruple in size.

Dynamic Range

The range of values between the darkest and brightest perceptible points in an image is dynamic range, a term principally used to describe video and digital images. It can be compared to film's exposure latitude. The bit depth chosen in digital image files at acquisition determines how much dynamic range is acquired. The higher the bit depth, the better the dynamic range.



Bit Depth

Bit depth determines how much dynamic range will be acquired. The higher the bit depth, the larger the range of values that are captured and encoded for each color channel.

The dynamic range of a digital file can be represented either linearly or logarithmically:

- **Linear:** At acquisition, your film's dynamic range can be represented linearly—the complete tonal range from black to white is divided equally, from brightest to darkest values, and then encoded. This is not proportional to the sensitivity of the human eye, which more easily discerns blacks and shadows. To achieve enough precision in the darker areas to match the sensitivity of the human eye, more bits of information may be needed. Because information bits added linearly are spread equally across the entire tonal range, additional bits are also added to the midtones and highlights.
- **Logarithmic:** At acquisition, your film's dynamic range can also be represented logarithmically—the complete tonal range from black to white is encoded logarithmically. Thus, more bits of information are assigned to the image's darker areas. A logarithmic representation closely matches the sensitivity of the human eye, which more easily discerns blacks and shadows and helps capture the full dynamic range across a smaller number of bits.

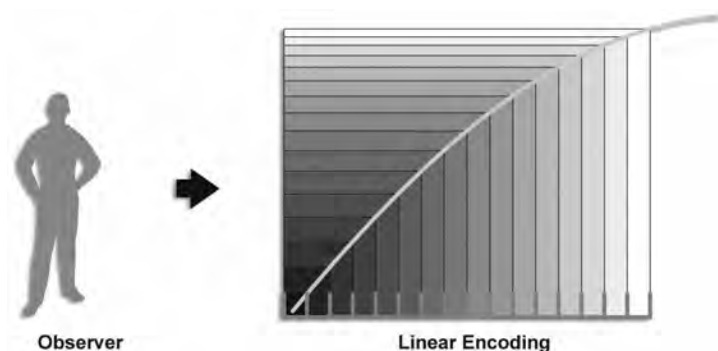

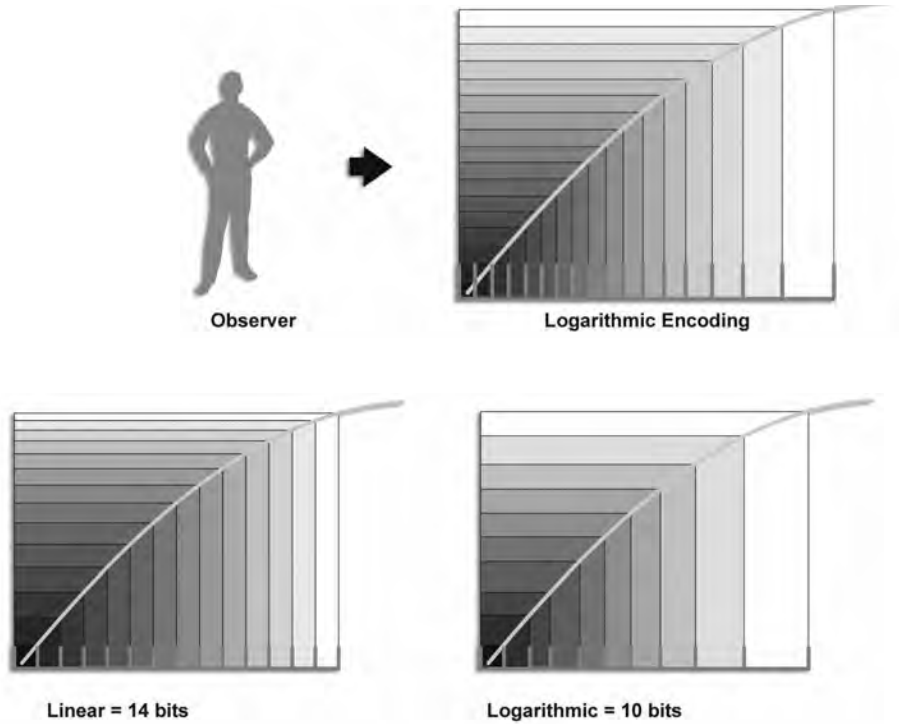

DPX Files

The film is scanned after resolution and bit depth are set, resulting in a series of digital image files. The most common file format is the Digital Picture Exchange file (DPX file). The DPX format is an ANSI and SMPTE standard. The flexible format is easy to share between workstations, equipment, and facilities. The format is resolution independent and various bit depths can be assigned, and it can represent the dynamic film range linearly or logarithmically.

IMAGE PROCESSING

After digitization, entire scenes, individual frames, and even individual pixels on a frame can be manipulated with precise control in the image processing stage. The DI environment is interactive, allowing the creation of custom looks and experimentation in real time.



Editing

Editing combines shots and sequences into a continuous narrative that captures and holds the audience's attention. The editor, in consultation with the director and producer, decides which scenes and takes to use, when, and in what sequence. Once editing is complete, takes used in the final edit are scanned, and the EDL is used to auto-conform the digital intermediate.

Digital Effects

Complex, computer-generated special effects are often completed while the movie is being edited. Then they are integrated into the digital files that make up the digital intermediate. Sometimes the computer hardware and software used to generate special effects is proprietary to your post-production facility.

Color Correction

A colorist modifies the color and contrast of scenes according to your input. It is important to use a post house that routinely calibrates hardware to ensure a color-calibrated workflow.

Dust Busting

Dust busting removes visible dust and scratches after film has been digitized.

Sound Editing

Audio recorded during image capture may have extraneous noise or poor quality. Sound elements such as dialogue, sound effects, music, and narration are improved and carefully mixed into a final soundtrack. The soundtrack is added to a production once editing is complete.

Film Recording

Film recording takes place after image processing. The scanned, edited, and color-corrected digital image is recorded back to film using a film recorder.

Video Mastering

Video mastering, or rendering, also takes place after image processing. The edited digital image data is used as a digital master to render all electronic formats such as digital cinema, HD, DVD, and SD.

Conforming

Conforming, the first step in image processing, matches the entire digital intermediate with the final edit. Special conforming software is used to auto-conform the digital intermediate by using the editor's EDL.

Conforming software and systems have some common features:

- **Playback:** The conforming system is often used for playback. Since the digital intermediate is a series of digital files, they can be played back and accessed in any order. This flexibility allows quick navigation to any point in the production. Often additional hardware is used to display and play back uncompressed high-resolution data. Or the conforming system can display proxies, which are smaller files used for playback and manipulation. Since the images are smaller, they are not as taxing on computer systems. Any adjustments made to proxy images can be saved as metadata and applied to

the full resolution images later. Using proxies can help save money. The smaller files are much easier and faster to process than full resolution scans.

- **Editing capabilities:** Most conforming software uses a timeline interface similar to non-linear editing software where frames can be duplicated, moved, replaced, or removed. The timing of cuts and transitions can also be modified. It is important to scan handles—extra footage before and after shots—so adjustments can be made. Handles allow some flexibility if a shot or transition needs extra frames.
- **Resolution independent:** Conforming systems are resolution independent—they can playback and access digital images of any size. Therefore, different capture media can be mixed together in its native resolution. Once the digital intermediate is complete, all the digital images are resized to the output resolution.
- **Conformed digital intermediate:** Once the DI is conformed, it should be compared to the original edit for accuracy. The major benefit of a conformed DI is that all changes made throughout the digital post-production process are performed in the final production context. You and the colorist, therefore, can experiment and directly assess changes to the film.

Digital Retouching

Digital retouching fixes imperfections in and damage to the digital images:

- **Dust busting:** Dust busting removes dust by cloning the same area on adjacent frames. The cloned information is used to fix the dust defect on the affected frame. Since images in a sequence are similar frame to frame, and the position of dust is random, this technique works well.
- **Digital paint:** Some imperfections found in scanned files can include scratches, chemical stains, and tears. An operator copies pixels from a good frame, and pastes them in the same area on a damaged frame.
- **Image sharpening:** Soft images resulting from degradation or poor lighting can be sharpened with algorithms. They detect edges in a digital image and then increase their contrast to make the image appear sharper.
- **Grain reduction:** While some grain is pleasing to the eye, too much can be distracting and obscure important detail. Grain reduction algorithms can reduce the amount of grain. Too much grain reduction, however, can soften an image.

Color Grading

We respond to colors because they symbolize and trigger emotions and memories. In the digital intermediate environment, color grading is not only used to establish continuity between shots and scenes, but to provide emotion to help tell the story.

The DI process can allow you to work closely with the colorist in an interactive and collaborative environment. Images are graded with playback in real-time using a color grading system. An experienced colorist can make an enormous difference in the look of a project. The grading process has two main stages: primary color correction and secondary color correction.

- **Primary color correction:** Primary color correction is completed first and sets the overall color balance. This first pass ensures that all scenes have a consistent color tone, with no sudden shifts in hue or brightness. The overall goal is to establish the base look and continuity between shots.
- **Secondary color correction:** Color adjustments to a specific item in a scene are possible with secondary color correction. Secondary color correction allows selection and manipulation of specific colors or objects without affecting the overall balance. This control allows you to warm up skin tones or to make the sky in a scene bluer.

Masks

A section of an image is often selected in secondary color correction with a mask. Masks can be compared to stencils placed over an image. Parts of the image are protected, while the openings are edited.

Shots often contain objects that move or have camera movement, changing a frame's content over time. Many grading systems provide the ability to animate masks in order to isolate and grade moving objects. Sequences containing complex shapes may require rotoscoping, which is accomplished by adjusting a mask frame by frame.

Many color-grading and digital post-production techniques can alter the principal photography significantly. They can:

- Emulate light
- Recompose shots
- Use motion stabilization
- Add vignettes, gradients, and highlights to lead the eye
- Emulate traditional camera filters and processing techniques

Metadata

Many changes, such as color grading changes, are stored as metadata. Metadata is information about a digital file or how it should be processed. This process is non-destructive, which means all color-grading changes are saved without actually altering the original content. Systems can read the metadata and play back a preview as if the changes were applied. When all image processing steps are complete, all metadata is applied at output.

Special Effects

A digital intermediate facility can perform many traditional optical effects digitally. The facility also works with effects departments to integrate computer-generated material and composites.

A variety of traditional optical effects can be completed digitally:

- Transitions such as wipes, fades, and dissolves
- Image alterations such as cropping, flipping, resizing, and repositioning
- Freeze frames
- Speed effects
- Titles and text

Computer Generated Material

Productions often integrate computer-generated material into the digital intermediate. This material is often created by specialized departments and can include:

- Still and motion graphics
- 3-D animation
- Digital composites

OUTPUT

Rendering applies all changes made throughout image processing on a digital source master. Rendering all the frames in the digital intermediate taxes computer systems and requires a significant amount of computer processing. Rendering is often completed on a rendering farm, which divides the task among several systems networked together to expedite the process.

Digital Master

The digital master is a final digital version with all changes applied. It is used to create all distribution formats, including:

- Film for release printing
- Digital cinema
- HD
- SD
- DVD
- Content for the Web

Video Output

The digital master is used to render all video formats for video output. Each video format has its own specifications and must be rendered out separately. Typically video output is a process of down conversion. The digital master is usually higher in resolution and has a larger color gamut. Here are some important considerations when outputting various video masters for video distribution.

Frame Rate: Film is captured and displayed at 24 frames per second. Video runs at 30 or 25 frames per second. Since film and video run at different rates, there is not a simple one-to-one relationship. For NTSC, which runs at 30 frames per second (60 fields per second), the difference in frame rates is solved by what is known as 3:2 pull-down. At output, the first film frame is transferred into the first 3 fields of video. The second film frame is transferred into the next two fields of video. This sequence of three fields, then two, continues until all 30 frames (60 fields) of video have been filled from 24 frames of film. This process allows film to play at the correct speed on video. For PAL transfers, the ratio is much closer: 24 frames of film for 25 frames of video. To avoid pull-down and establish a one-to-one relationship, it is common for film seen on PAL television to be transferred at 25 frames per second. Action onscreen is about four percent faster, a barely discernable increase. If sound pitch is critical, the track can be processed and pitch-corrected.

Color Space: Each video format has a color space. The RGB color space used during image processing is larger than that of video. This means that some colors are out of gamut and will not appear when broadcast. Most systems convert the color space to video safe colors at output, or a look-up table can be used to convert the colors to the appropriate color space.

Aspect Ratio: Video formats have different aspect ratios, and there are a variety of techniques available to adjust the image for video output. HDTV has an aspect ratio of 1.78:1. This wide aspect ratio works well for wide screen film images.



Very little of the image requires cropping. Transferring wide-screen films to the standard 1.33:1 television aspect ratio poses a challenge because the entire film frame will not fit. Options include:

- **Squeeze:** The wide image is squeezed onto a standard video frame. Image distortion results.



- **Pan and Scan:** After the height of the film frame is maximized, the operator pans back and forth selecting the best part of the film frame for each scene. This technique shows important action occurring inside the television frame, but alters the original composition.



- **Letterbox:** Letterbox is a standard television display technique used more frequently in recent years. A black band on the top and bottom of the screen is used to maintain a wide-screen look, preserving the original composition on a standard television screen.



Film Output

The digital master is output to an internegative with a film recorder for film distribution. The internegative is then sent to the lab for traditional release printing and then distributed to theaters. Traditional film duplication is simplified because all color-grading decisions were applied digitally during image processing. This removes the need to make major color timing adjustments during printing.

Digital Cinema

A digital cinema distribution master can be created for theatrical release. Digital cinema projects images from a digital file. It is important to ensure that the digital cinema distribution master has the overall look, color, and contrast, of film prints.

COLOR MANAGEMENT

Controlling the way films are viewed is as important as quality control during the digital post-production process. The ability to view color fidelity, and make decisions based on those views, are integral to filmmaking.

Color management is the use of appropriate hardware, software, and procedures to achieve consistent color throughout digital post-production. There are two main goals in color management:

- All displays must provide consistent color.
- What is seen on displays is faithfully reproduced at final output.

Calibration

Each device in post-production must be calibrated to ensure that all devices display the same image:

- **Film scanners:** Scanning a series of gray and color patches of known density provides the aim for the scanner calibration. This ensures consistent input for subsequent workflow processes.
- **Monitors:** Calibration checks the monitor brightness, contrast, and color temperature for accurate color reproduction. Calibration is achieved by using a colorimetric sensor to measure the color output of the monitor. The output of the display is measured against defined input values.

The measurement establishes a profile for the device. This profile is used to help display images accurately. Another important consideration for monitors is the viewing environment and the ambient light level. Ambient light can compete with the screen and cause color to look muted.

- **Digital projectors:** Many times the principal output medium will determine how the production is displayed in the DI environment. If the principal output medium is film release or digital cinema, it is best to project it for operations such as color grading. It is important that the projector is calibrated and accurately represents the color and density of the final film print.
- **Film recorder calibration:** Recording a series of gray and color patches of known density provides the aim for the recorder calibration. This will ensure consistent output for film prints.

Once all devices in digital post-production are calibrated to the same standard, the target output must be accurately displayed. Each display device and output medium has its own color gamut. The goal is to achieve the most accurate representation of the target output medium on the display. If a project is to be printed out to film, the most accurate representation of film should be displayed on monitors in digital post-production.

Look-up Tables

Look-up tables (LUTs) are used to adjust and accurately display the target output.

1-Dimensional Lookup Table

A 1-Dimensional Lookup Table is a static color translation table that converts one input value to one output value. It is an effective way to link two values together. A phone book is an example of a 1D LUT—for every name in the book there is a phone number. The 1-to-1 correspondence is simple to construct and to use.

3-Dimensional Lookup Table

A 3-Dimensional LUT is a static color translation table that converts a set of three-input color values to another set of three-output color values. A 3D LUT is often used to check for accurate color rendition between different color spaces. A colorist may use a 3D LUT to convert a red, green, and blue density color space to RGB monitor drive values for video.

Since LUTs link values together, they help speed up post-production processes.

LUTs provide feedback in real time and are often used to implement:

- Calibration corrections
- Color corrections
- Specific looks
- Color space conversions

“We were shooting with a handheld camera and no time to light. I exposed the negative so the exterior wouldn’t blow out and the faces wouldn’t be too dark. In DI, I could tweak those shots by making faces a little brighter and the outside a little darker, if necessary. DI is a creative tool that allowed us to shoot in Super 16 format and record directly onto 35 mm film without an optical blow-up.”

—*Christian Sebaldt, ASC, Cinematographer*

APPENDIX: FILMMAKER'S CHECKLIST

The cinematographer is responsible for selecting, ordering, preparing, and maintaining (with the technical crew's assistance) all camera and support equipment deemed necessary for the production.

When ordering the camera package, it is important to include all items needed to photograph the project. The following lists include key elements typically requested.

CAMERA BASICS: (FROM GROUND UP)	CAMERA ACCESSORIES:	SUPPLIES:
<ul style="list-style-type: none"> ▪ Spreader ▪ Hi-hat ▪ Tripods (standard and baby) ▪ Tripod head ▪ Camera body (and a backup camera body whenever shooting in remote locations) ▪ All necessary cables ▪ Magazines (small and large) ▪ Lenses (primes, zooms) ▪ Zoom motor and control ▪ Follow-focus unit ▪ Matte box ▪ Filters and holders ▪ Changing bag or tent 	<ul style="list-style-type: none"> ▪ Adapter plates (quick-release, dovetail/balance, riser, tilt) ▪ External speed and sync control ▪ Remote control for aperture, shutter angle and ramping ▪ Electronic focus control or rangefinder ▪ Set of hard mattes, eyebrow ▪ French flag ▪ Handheld accessories (matte box, follow-focus, shoulder pad, viewfinder, magazines) ▪ Viewfinder extender and leveller ▪ Barneyes ▪ Rain shields ▪ Obie light ▪ Assistant light ▪ Videotape ▪ Monitor ▪ Recorder ▪ Time code device 	<ul style="list-style-type: none"> ▪ Film stock ▪ Light meter ▪ KODAK Gray Card Plus ▪ Camera reports ▪ 100-ft (30 m) camera spool* ▪ 200-ft (61 m) camera spool* ▪ Spare film cores (6 minimum) ▪ Empty film cans ▪ Black lab-pack bags ▪ Labels ▪ Assorted filters (85, 81EF, LLD, complete set of neutral density filters; yellow filters Nos. 2 thru 8 for B/W film) ▪ Black camera tape ▪ White cloth camera tape ▪ Cloth camera tape ▪ Paper tape ▪ Highest quality gaffer's tape (NOT duct tape) ▪ Lens tissue ▪ Lens-cleaning solvent ▪ Camel-hair lens brush ▪ Cleaning swabs ▪ Orangewood sticks ▪ Camera oil ▪ Clapper/slate ▪ Spare camera fuses ▪ Canned air ▪ Insert slate ▪ Log sheets ▪ Dental mirror ▪ Magnifier
		<p>*Load and unload all camera spools in subdued light</p>

UTILITY BAG:	TOOLS FOR CAMERA MAINTENANCE:	MAINTENANCE TOOLS:
<ul style="list-style-type: none"> ▪ SANFORD SHARPIE, both fine and ultra-fine point ▪ Ear syringe ▪ Felt markers ▪ Grease pencils ▪ Pens and pencils ▪ Chamois ▪ Chalk ▪ Small mag-type flashlight ▪ Magnifying glass ▪ Masking tape ▪ Scissors ▪ Tweezers ▪ Orange sticks ▪ American Cinematographer Manual ▪ Pencils and ballpoint pens ▪ Screwdrivers ▪ Paint brush (1-inch size with tapered bristles is preferred) ▪ Leak-proof precision oil can (the kind that looks like a fountain pen) ▪ Rubber bands ▪ Black cloth ▪ Magazine belt clips and pick 	<ul style="list-style-type: none"> ▪ Longnose pliers ▪ Diagonal cutters ▪ Channel lock pliers ▪ Screwdrivers—standard and Phillips head ▪ Jeweler’s screwdriver set ▪ Allen wrenches ▪ Open end and box wrench sets ▪ Files (for metal and wood) ▪ Pocket knife ▪ “C” clamps 3-in. (7.5 cm) ▪ Spring clamps ▪ Scriber ▪ 1/4 x 20 screws 1 and 2 1/2-in. long ▪ 3/8 x 16 screws 1 and 2 1/2-in. long ▪ Tape measures (one 12 ft and one minimum 50 ft) ▪ Voltmeter (with adequate range to cover anticipated voltages) ▪ Electrical tape ▪ Ground adapters (both the 3-pin plug adapter and water pipe clamp types) ▪ Electric drill and bits, up to 3/8 in. (0.75 cm) ▪ DREMEL Tool Kit and bits ▪ Soldering iron and solder ▪ Batteries: AA (12), AAA (12), 9V (4), and at least (2) spare batteries for light meter ▪ Small and medium crescent wrenches ▪ Expansion bit (and bit brace, if not electric) ▪ KODAK Gray Card Plus ▪ Canned air ▪ Blank camera reports ▪ Clapper board 	<ul style="list-style-type: none"> ▪ Steady tester or registration chart ▪ Flange gauge ▪ Crystal strobe gun

GLOSSARY OF MOTION-PICTURE TERMS

— # —

1D LUT: A 1-dimensional lookup table is a static color translation table that converts one input value to one output value. There is a 1-to-1 correspondence in the input and output values in a 1D LUT.

16 mm: The frame is one-fourth the size of a 35 mm frame and has a 1.33:1 television aspect ratio. The film can have perforations on both sides or on just one side. When compared to 35 mm, grain is more apparent.

2K: A digital image 2048 pixels wide. A standard 2K scan of a full 35 mm film frame is 2048 X 1556 pixels.

3:2 Pull-down: The telecine transfer relationship of film frames to video fields. Film shot at 24 fps is transferred to 30 fps NTSC video with an alternating three-field/two-field relationship.

3D LUT: A 3-dimensional lookup table is a static color translation table that converts a set of three input color values to another set of three output color values.

35 mm: The standard gauge for professional filmmakers, and the standard mainstream film format used for theatrical releases.

4K: A digital image 4096 pixels wide. A standard 4K scan of a full 35 mm film frame is 4096 X 3112 pixels.

65 mm: The camera film format (size) for wide-screen formats such as IMAX.

70 mm: The release print format (size) for wide-screen formats such as IMAX.

— A —

A Wind: When you hold a roll of 16 mm or other single-perf film so that the film leaves the roll from the top and toward the right, the perforations will be along the edge toward the observer.

Abrasion Marks: Scratches on film caused by dirt, improper handling, grit, emulsion pileups, and certain types of film damage (e.g., torn perforations).

Academy Aperture: In projection, the aperture cutout, designed as specified by the American Academy of Motion Picture Arts and Sciences that provides for a screen-image aspect ratio of approximately 1.37:1; also called "sound aperture."

Acetate: Actually cellulose triacetate, the base material frequently used for motion picture films. Also, in sheet form, for overlay cells.

Acetate-Base Film: Any film with a support that contains cellulose triacetate; safety film.

Acquisition: General term used to describe the input of media for the DI process. All source media during acquisition must be digitized or transferred digitally.

Additive Color: Color mixture by adding light from any of the three primaries: red, green, and blue.

Algorithm: A procedure to perform a task. Given an initial state, an algorithm will produce a defined end-state. Computer algorithms are used to perform image-processing operations.

Aliasing: A digital artifact consisting of patterns or shapes that have no relation in size and orientation with those found in the original image. This is often caused by too low a scan resolution or sampling rate. The best solution is to acquire the image at a sufficient sampling rate or use an anti-aliasing algorithm.

Analog: A recording technique (for video or audio) that is continuously variable (as opposed to digital, which is either on or off using 1's and 0's).

Anamorphic: An optical system having different magnifications in the horizontal and vertical dimensions of the image. Basically, special camera lenses squeeze the image horizontally at the time of exposure. This 2-to-1 squeeze uses as much of the negative available and still allows room for an optical sound track on the release print. The print is un-squeezed by the projector lens, which gives the characteristic wide screen (2.35:1) aspect ratio.

ANSI: American National Standards Institute.

Answer Print: The first print (combining picture and sound, if a sound picture), in release form, offered by the laboratory to the producer for acceptance. It is usually studied carefully to determine whether changes are required prior to printing the balance of the order.

Antihalation Backing (Coating): A dark layer coated on or in the film to absorb light that would otherwise be reflected back into the emulsion from the base.

Aperture: (1) Lens: The orifice, usually an adjustable iris, which limits the amount of light passing through a lens. (2) Camera: In motion picture cameras, the mask opening that defines the area of each frame exposed. (3) Projector: In motion picture projectors, the mask opening that defines the area of each frame projected.

Artifacts (Digital Artifacts): Undesirable and unintentional defects in a digital image. Artifacts are often a result of image processing.

ASA: Stands for American Standards Association, now International Standards Organization. Exposure Index or speed rating that denotes the film sensitivity. Actually defined only for black-and-white films, but also used in the trade for color films.

Aspect Ratio: Proportion of picture width to height. Some common aspect ratios include 1.85:1 (Academy Standard), 2.39:1 (Anamorphic), 1.78:1 (HD), and 1.33:1 (SD).

Asset Management: Managing, tracking, and storing data throughout the entire digital intermediate process.

Average Gradient: A measure of contrast of a photographic image, representing the slope of a line from two points located on a portion of a characteristic curve. The term that refers to a numerical means for indicating the contrast or the photographic image.

— B —

B Wind: When you hold a roll of 16 mm or other single-perf film so that the film leaves the roll from the top and toward the right; the perforations will be along the edge away from the observer.

Backing: Coating: (e.g., anti-abrasion coating, anti-curl, or remjet backing) applied to the base side of the film to improve characteristics and performance.

Banding: Smooth graduated colors reduced to larger blocks of color. This produces a visible stepping of shades in the image.

Base: The transparent, flexible support, commonly cellulose triacetate (in motion picture cameras), on which photographic emulsions are coated to make photographic film.

Base Plus Fog: Density of the film support plus the silver or dye produced by the effects of the developer. Pertains only to an unexposed portion of the film.

Bell And Howell Perforation (BH): A film perforation shaped with flat top, flat bottom, and curved sides.

Bit: Binary digit, the smallest unit of digital information a computer can work with.

Bit Depth: The number of possible color values used in a digital image. A higher bit depth improves the tonality of an image because there are more color values to choose from.

Bitmap (Raster Image): A digital image formed by pixels mapped on a grid. Each pixel has its own color or grayscale value.

Black-And-White Film: A film that produces a monochromatic picture in shades of gray (usually a metallic silver image).

Bleach: (1) Converting a metallic silver image to a halide or other salt that can be removed from the film with hypo. When bleaching is not carried to completion, it is called reducing. (2) Any chemical reagent that can be used for bleaching.

Blowdown: Reducing a larger format to a smaller format. An example of blowing down would be going from Super 16 down to 16 mm.

Blowup: Occurs when a smaller film format is increased to a larger format. An example would be going from Super 16 up to 35 mm.

— C —

CCD (Charged Coupled Device): A chip with a fixed arrangement of sensors that convert light into electrical current. Each electrical current is in proportion to the amount of light hitting each sensor on the CCD. The electrical current is converted to digital data to create a digital image.

Calibration: Sets each device in the post-production pipeline to a specific standard. Calibration ensures all devices acquire, display, and output an accurate image.

Camera Log: A record sheet giving details of the scenes photographed on a roll of original negative.

Camera Original: Film exposed in a camera.

Cellulose Triacetate: Also referred to as "acetate." A transparent, flexible material used as a base support for photographic emulsions.

Characteristic Curve: Shows the relationship between the exposure of a photographic material and the image density produced after processing.

Check Print: Used to check the quality of the bulk release work, these are made from the duplicate negative.

Cinch Marks: Short scratches on the surface of a motion picture film which run parallel to its length. These are caused by dust or other abrasive particles between film coils or improperly winding the roll, which allows one coil of film to slide against another.

Cinching: Practice of pulling the end of a film roll to tighten it. It's not recommended.

CINEMASCOPE: Trademark name of a system of anamorphic wide-screen presentation, the first commercially successful anamorphic system for the presentation of wide-screen pictures combined with stereophonic sound. The 35 mm negative camera image is compressed horizontally by 50 percent using a special anamorphic camera lens. Upon projection, the 35 mm print image is expanded horizontally by the same amount using a similar anamorphic projection lens. Depending on the type of sound used in the print, the screen image has an aspect ratio of 2:35:1 (optical sound), or 2:55:1 (4-track magnetic sound).

Color Analyzer: A device for determining the correct printing light ratios for printing color negatives.

Color Balance: The perceptual appearance of a color image of film as a function of the ratio of exposures of each of the primary color records on the film.

Color Channel: An RGB image is comprised of three different color channels: red, green, and blue. Each channel acts as a layer that stores tonal information. All three channels combined create the colors in the digital image.

Color Correction: The altering of the color balance by modifying the ratio of the printing light values.

Color Correction (Digital Color Grading): Process of adjusting the color and look of images in digital post-production. Digital color correction allows far more control than tradition color timing.

Color Film: Carries one or more emulsions, sensitive to different colors, and forming corresponding dye colors during processing.

Color Internegative: Negative-image color duplicate made from a positive color original. Typically used for making release prints.

Color Management: Use of appropriate hardware, software, and procedures to achieve consistent color throughout the entire digital post-production pipeline.

Color Negative: A negative (opposite) record of the original scene. Colors are complementary to the colors in the scene; light areas are dark, and dark areas are light.

Color Negative Film: Film that after processing has a color negative image. The most common film used.

Color Positive: A positive record of the original scene.

Color Print Film: Film designed for making positive prints from color originals and color duplicates.

Color Reproduction: Refers to the hue quality of rendered colors. This can include color accuracy (in memory colors or in various flesh tones), color preference, flesh-to-neutral reproduction, and tone-scale neutrality.

Color Reversal Film: Film that after processing has a color positive image. Can be an original camera film or a film in which other positive films are printed.

Color Saturation: A term used to describe the brilliance or purity of a color. When colors present in a film image are projected at the proper screen brightness and without interference from stray light, the colors that appear bright, deep, rich, and undiluted are “saturated.”

Color Sensitivity: Portion of the spectrum to which a film is sensitive. The ability of the eye or photographic stock to respond to various wavelengths of light.

Color Separation Negative: Black-and-white negative made from red, green, or blue light from an original subject or from positive color film.

Color Space: The range of colors a system is able to reproduce. Digital intermediate work is typically done in the RGB color space.

Color Temperature: The color quality expressed in degrees Kelvin (K)—of the light source. The higher the color temperature, the bluer the light; the lower the temperature, the redder the light.

Color Timing: A laboratory printing process whereby the negative is graded for color and density. A color timer uses a color analyzer to look at and adjust the colors of every scene in the movie. The analyzer has controls for each of the three primary colors: red, green and blue, and overall density.

Colorist: Colorists are artists who work closely with the filmmaker to color correct the film. They help the filmmaker achieve the overall “look” they desire. Using their knowledge of color, they establish continuity between shots and make color decisions that support the story.

Complementary Color: Color that is minus one of the primary colors. Cyan is minus red—cyan and red are complementary colors; yellow is minus blue—yellow and blue are complementary colors; magenta is minus green—magenta and green are complementary colors. A color that produces white when mixed in equal parts with the primary color to which it is complementary.

Composite Print: A print of a film that contains both picture and sound track. Films regularly shown in theaters are composite prints. Also called Release Print.

Composition: The distribution, balance, and general relationship of masses and degrees of light and shade, line, and color within a picture area.

Compression: Algorithms that discard or reorganize information to reduce file size. Compression reduces the amount of storage space and bandwidth needed for images in the digital intermediate.

Conform: Match the original film to the final edited work print.

Conforming (Auto-conforming): Matching the digital intermediate to the final edit. Special conforming software is used to auto conform the digital intermediate by using an edit decision list or a film cut list provided by the editor.

Contact Print: Print made by exposing the receiving material in contact with the original. Images are the same size as the original images, but have a reversed left-to-right orientation.

Continuous Contact Printer: A printing machine where the emulsion of the negative film is in direct physical contact with the positive raw stock emulsion, and the two films are moving continuously across the printing aperture.

Contrast: (1) The general term for describing the tone separation in a print in relation to a given difference in the light-and-shade of the negative or subject from which it was made. Thus, "contrast" is the general term for the property called "gamma" (γ), which is measured by making an H & D Curve for the process under study. (2) The range of tones in a photographic negative or positive expressed as the ratio of the extreme opacities or transparencies or as the difference between the extreme densities. This range is more properly described as "scale" or "latitude." (3) The ability of a photographic material, developer, or process as a whole to differentiate among small graduations in the tones of the subject.

Control Strip: A short length of film containing a series of densities to check on laboratory procedures.

Cross Process: Shooting color reversal film but processing as a color negative film, resulting in an "alternate" look.

Curl: A defect of a photographic film consisting of unflatness in a plane cutting across the width of the film. Curl may result from improper drying conditions, and the direction and amount of curl may vary with the humidity of the air to which the film is exposed.

Curve (H&D): The characteristic curve developed by Hurter and Driffield that depicts how faithfully a photographic emulsion has reproduced the tonal scale of the original scene.

Cyan: Blue-green; the complement of red or the minus-red subtractive used in three-color processes.

— D —

D-Log E: (Density vs. the log of Exposure) The graph made by plotting the density of a film sample against the log of the exposure that made that density. Also known as D-Log H, H and D, and characteristic curve. D-Log H (H for exposure) is the technically correct term.

D Log H Curve: The curve showing the relation between the logarithm of the exposure and the resultant density on processed film. Also called the characteristic curve.

D-Max: See Maximum Density.

D-Min: See Minimum Density.

Dailies: Picture and sound work prints of a day's shooting; usually an untimed one-light print made without regard to color balance. Produced so that the action can be checked and the best takes selected; usually shown before the next day's shooting begins.

Daylight: Light consisting of a natural combination of sunlight and skylight (approximately 5500 degrees K).

Definition: The clarity or distinctness with which detail of an image is rendered. Fidelity of reproduction of sound or image.

Densitometer: Instrument used to measure the optical density of an area in a processed image by transmittance (for films) or by reflectance (for photographic prints).

Densitometry: Science of measuring the light-stopping characteristics of film or filters.

Density: Light-stopping characteristics of a film or a filter. The negative logarithm to the base ten of the transmittance (or reflectance) of a sample.

Depth of field: The distance range between the nearest and farthest objects that appear in acceptably sharp focus. Depth of field depends on the lens opening, the focal length of the lens, and the distance from the lens to the subject.

Development: Process of making a visible film image from the latent image produced during exposure.

Developer: A solution used to turn the latent image into a visible image on exposed films.

Diffuse RMS Granularity: The objective measurement of grain.

Digital: A system whereby a continuously variable (analog) signal is broken down and encoded into discrete binary bits that represent a mathematical model of the original signal.

Digital Cinema Distribution Master (DCDM): Digital content that conforms to specifications set by the Digital Cinema Initiatives (DCI). The DCDM is a set of digital files that include images, audio, subtitles and other auxiliary data.

Digital Intermediate: A project in its digital state between input and final output. The digital intermediate goes through many different processes such as digital retouching, digital color grading, integration of visual effects and titling. Therefore, the term “digital intermediate” refers to the digital data’s transitional nature—a state between the input stage and final delivery.

Digital Master: Final digital version with all changes in the image processing stage applied. It is used to create all distribution formats, including film, digital cinema, HD, SD, and DVD.

Digital Paint: Software tools and techniques to fix imperfections in digital images.

Digitization (Digitize): Process of sampling and converting a continuously variable (analog) signal into discrete mathematical representation of that signal.

Dissolve: An optical or camera effect in which one scene gradually fades out at the same time that a second scene fades in. There is an apparent double exposure during the center portion of a dissolve sequence where the two scenes overlap.

Double-System Sound Recording: Includes a film camera and a separate device, such as a DAT, for audio. For accuracy, the camera should be synced with the sound device and the frame rate should be a constant 24 frames per second. Sound is later transferred to magnetic film and synchronized with picture in postproduction.

Downrezzing (Downsampling): Resizing a digital image to a smaller size.

DPX (Digital Picture Exchange) File: The most common file format used in digital post-production. The DPX format is an ANSI and SMPTE standard. The format provides a great deal of flexibility because it is easy to share between workstations, equipment, and facilities.

Dupe, Dupe Negative: A second generation internegative made from a master positive by printing and development or from an original negative by printing followed by reversal development.

Dust-Busting: Removal of visible dust and scratches after film has been digitized.

Dynamic Range: The range of values between the darkest and brightest perceptible points in an image.

Dye: In photography, the result of color processing in which the silver grains or incorporated color couplers have been converted into the appropriate dye to form part of the color image.

— E —

ECN-2: Process for color negative films.

ECP-2: Process for color print films.

Edge Numbers: Numbers on edges of film that identify the film; used to help match original film and sound to edited workprints. Latent-image edge numbers are put on by the manufacturer, and appear during development. Printed edge numbers are placed on the film by the lab, and can be coded for all materials so that any number of picture and sound rolls will have the same sequence. See also KEYKODE.

Edgewax: Waxing method recommended for lubricating release prints; treatment is with a solution of 50 grams of paraffin wax per litre of trichloromethane applied only to the edges of the emulsion side of the film.

EDL (Edit Decision List): List of edits prepared on a non-linear editor in timecode.

Emulsion, Emulsion Layer: (1) Broadly, any light-sensitive photographic material consisting of a gelatin emulsion containing silver halides together with the base and any other layers or ingredients that may be required to produce a film having desirable mechanical and photographic properties. (2) In discussions of the anatomy of a photographic film, the emulsion layer is any coating that contains light sensitive silver halide grains, as distinguished from the backing, base, substratum, or filter layers.

Emulsion Number: A number identifying a complete coating from a single emulsion batch or mixture.

Emulsion Side: The side of a film coated with emulsion.

Emulsion Speed: The photosensitivity of a film, usually expressed as an index number based on the film manufacturer's recommendations for the use of the film under typical conditions of exposure and development.

ESTAR Base: The trademark name applied to the polyethylene terephthalate film base manufactured by Eastman Kodak Company.

Exposure: Amount of light that acts on a photographic material; product of illumination intensity (controlled by the lens opening) and duration (controlled by the shutter opening and the frame rate).

Exposure Index (EI): Number assigned to a film that expresses its relative sensitivity to light. The EI is based on the film emulsion speed, a standard exposure technique, and specific processing solutions.

Exposure Latitude: Degree to which film can be underexposed or overexposed and still yield satisfactory results.

Exposure Meter, Incident: A meter calibrated to read and integrate all the light aimed at and falling on a subject within a large area. (Scale may be calibrated in footcandles or in photographic exposure settings.)

Exposure Meter, Reflectance: A meter calibrated to read the amount of light, within a more restricted area, reflecting from the surface of a subject or an overall scene. (Scale may be calibrated in footcandles or in photographic exposure settings.)

Exposure Setting: The lens opening selected to expose the film.

— F —

f-Number: A symbol that expresses the relative aperture of a lens or f/stop. For example, a lens having a relative aperture of 1.7 would be marked f/1.7. The smaller the f-number, the more light the lens transmits.

Fast: (1) Having a high photographic speed. The term may be applied to a photographic process as a whole, or it may refer to any element in the process, such as the optical system, emulsion, developer. (2) Resistant to the action of destructive agents. For example, a dye image may be fast to light, fast to heat, or fast to diffusion.

Ferrotyping: Shiny blotches on the surface of processed film; caused by heat and/or moisture combined with pressure.

Film Base: Flexible, usually transparent, support on which photographic emulsions are coated.

Film Code: (or product code) is the four-digit number that the film manufacturer assigns to every film product, e.g., 5201.

Film Cut List: List containing KEYCODE Numbers that communicates what frames from the original negative should be included in the conformed negative (traditional) or digital intermediate (digital post).

Film Gate: Components that make up the pressure and aperture plates in a camera, printer, or projector.

Film Identification Code: Letter which identifies film type.

Film Perforation: Holes punched at regular intervals for the length of film, intended to be engaged by pins, pegs, and sprockets as the film is transported through the camera, projector, or other equipment.

Film Sensitivity: The ability of a photographic emulsion to form a latent image when exposed to light.

Film Speed: See Emulsion Speed.

Final Cut: Last editing of a workprint before conforming is done or before sound workprints are mixed.

Fine Grain: Emulsion in which silver particles are very small.

First Print: The first trial composite (married) print containing both picture and sound for the purpose of checking picture and sound quality.

Fixing: The removal of unexposed silver halides from the film during processing.

Flashing: Technique for lowering contrast by giving a slight uniform exposure to film before processing.

Flat: An image is said to be "flat" if its contrast is low. Flatness is a defect that does not necessarily affect the entire density scale of a reproduction to the same degree. Thus, a picture may be "flat" in the highlight areas, "flat" in the shadow regions, or both.

Flesh-to-Neutral Reproduction: A function of a film's tone-scale neutrality and linearity and its color reproduction. A good performer will offer a neutral tone scale from black to white when flesh tones are balanced to an accurate or preferred position, and vice versa—when flesh tones look reasonable when the film's gray scale is balanced to neutral.

Focal Length: The distance from the optical center of a lens to the point at which parallel rays of light passing through it converge (the focal point).

Fog: Darkening or discoloring of a negative or print, or lightening or discoloring of a reversal material. Causes include accidental exposure to light or x-rays, overdevelopment, using outdated film, and storing film in a hot, humid place.

Footage Numbers: Also called edge numbers or KEYCODE. Sequential numbers which are pre-exposed or printed in ink at regular intervals on the edge of the film outside or in between the perforations.

Force-Process: Develop film for longer than the normal time to compensate for underexposure. More commonly called "push process."

Format: The size or aspect ratio of a motion picture frame.

FPM: Feet Per Minute, expressing the speed of film moving through a mechanism.

FPS: Frames Per Second, indicating the number of images exposed per second.

Frame (film): The individual picture image on a strip of motion picture film.

Frame (video): A complete television picture made up of two fields, produced at the rate of approximately 29.97 Hz (color), or 30 Hz (black & white).

Frame Counter: An indicator that shows the exact number of frames exposed.

Frame Line Marking: A mark placed on the edge of the film between every fourth perforation as an aid to splicing in frame when no image or frame line is visible. On 70 mm film, a small punched hole placed between every fifth perforation.

Frame-Index Marker: (35 mm only) Hyphen that occurs every four perforations to help locate position of frame line, especially in low-light level scenes. To use: Locate frame line. Determine whether it is offset from index marker by 0, +1, +2, or +3 perforations. Use this offset to find frame line elsewhere in scene. Note: The frame-index marker is not printed when it interferes with any other edgeprint information.

Frame Rate: See FPS.

Front End: General terms for all production and preparation work up to the Answer Print stage before Release Printing.

— G —

Gamma: Measurement of the contrast of an image, representing the slope of the straight-line portion of the characteristic curve.

Gate: The aperture assembly at which the film is exposed in a camera, printer, or projector.

Gelatin Filter (Gel): A light filter consisting of a gelatin sheet in which light-absorbing pigment or dye is incorporated.

Gobo: A patterned template used in lighting to create a pattern or texture in a scene. Placed between the light and the subject, a gobo can add mood, dimension, or the illusion of motion.

Grain Reduction: Digital algorithms used to reduce the amount of undesirable grain in a sequence of images.

Graininess: The character of a photographic image when, under normal viewing conditions, it appears to be made up of distinguishable particles, or grains. This is due to the grouping together, or “clumping” of the individual silver grains, which are by themselves far too small to be perceived under normal viewing conditions.

Granularity: Nonuniformity in a photographic image that can be measured with a microdensitometer.

Gray Card: A commercially prepared card that reflects 18 percent of the light hitting it. Visually it appears neutral, or a middle gray halfway between black and white.

Grayscale: A black and white image.

Gross Fog: The density of the base of the film plus the density of the fog in the emulsion. Also known as D-min and base + fog.

Guillotine Splicer: Device used for butt-splicing film with splicing tape.

— H —

H&D Curve: The graph made by plotting the density of a film sample against the log of the exposure that made that density.

Halation: A defect of photographic films and plates. Light forming an image on the film is scattered by passing through the emulsion or by reflection at the emulsion or base surfaces. This scattered light causes a local fog that is especially noticeable around image of light sources or sharply defined highlight areas.

Hard: (1) As applied to a photographic emulsion or developer, having a high contrast. (2) As applied to the lighting of a set, specular or harsh, giving sharp dense shadows and glaring highlight.

HD: High definition video image or format.

HDTV: High Definition Television, a recently developed video format with a resolution approximately twice that of standard television.

High-Speed Camera: A camera designed to expose film at rates faster than 24 frames per second. Used to obtain slow-motion effects.

Highlights: Visually the brightest, or photometrically the most luminant, areas of a subject. In the negative image, the areas of greatest density; in the positive image, the areas of least density.

Highlight Detail: Almost entirely a function of shoulder contrast and overexposure latitude.

Hue: Sensation of the color itself, measured by the dominant wavelength.

Humidity: A term referring to the presence or absence of moisture in the air. For instance, low humidity describes conditions in a desert. Conversely, high humidity is related to tropical rain forest conditions.

Hyperfocal Distance: The closest focus distance at which both objects at infinity and closer objects are in focus.

— | —

Idle Roller: Free turning non-sprocketed rollers for guiding film through its appropriate path.

Illuminant: Light source used to project the film image or to expose the film.

Image, Latent Image: The invisible image formed in a camera or printer by the action of light on a photographic emulsion.

Image Orientation: Laboratory function that assures that the projected image is properly formed on the screen, and that the sound track is on the appropriate side of the film.

Image Processing Stage: Stage in the DI process where the digital intermediate files are manipulated and altered digitally. Operations such as conforming, color correction, creation of special looks, and addition of special effects are all performed digitally in the image processing stage.

Image Sensors: High-end video is limited to a fixed arrangement of sensors on the charge coupled device, or CCD.

IMAX: A widescreen format that originates on 65 mm film. Trademark of IMAX Corporation, the term applies more to “The IMAX Experience”—big film, special theatres, and surround sound.

Incident Meter: A light meter designed to measure light falling onto the subject.

Infrared: Nonvisible radiation from the long wavelength portion of the electromagnetic spectrum.

Input (Stage): Acquisition and transfer of all analog and digital media into the DI pipeline.

Intercutability: Can mean different things to different cinematographers. At the very least, it encompasses how well a group of films match one another for color reproduction, color saturation, contrast, tone-scale neutrality, flesh-to-neutral, and latitude. Chemically, there are also provisions made for how well dye sets match between films. If two films offer significant differences from one another in any of the above categories (different contrasts for example), they may still be considered artistically compatible or complementary, but not necessarily intercuttable.

Intermediate: Film used only for making duplicates from which other duplicates or prints are made. Does not include camera films.

Intermittent: Not continuous but equally spaced (sometimes random) motion, as the intermittent (24 fps) motion of film through a projector.

Internegative (IN): A negative copy made from the interpositive. The Internegative, also known as, a dupe negative (DN) can be printed with one-light (one set of timing lights) since all color corrections were made in the interpositive (IP). This facilitates high speed printing for theatrical releases.

Interpositive (IP): The original cut negative for a feature film is printed onto intermediate stock to create a color interpositive (or master positive). The same color timing for making the answer print is used here. With the IP in hand, an Internegative (IN or DN) is made which becomes the printing master or dupe negative (DN) for making multiple release prints.

Iris: See Aperture.

ISO: International Standards Organization. The international version of ANSI.

— J —

— K —

Kelvin: Unit of measure in color temperature (e.g., 6500K for daylight).

Key Numbers: See Edge Numbers.

KEYCODE: Technically, KEYCODE refers to the machine readable bar code next to the edge numbers that the manufacturer placed on the film. Over time it has become synonymous with edge numbers or footage numbers.

Kodak Standard Perforations (KS): Compared to BH perforations, larger in size, and with rounded corners for extra strength. Used primarily for release prints.

— L —

Laboratory: A facility that specializes in processing and printing film, sometimes offering additional services such as editing and film storage.

Laboratory Film: Film products, not intended for original photography, but necessary to complete the production process.

Latent Image: Invisible image in exposed, undeveloped film; results from exposure to light.

Latent Image Edge Numbering: Images placed on the edge of film products in manufacturing that become visible after development.

Latitude: In a photographic process, the range of exposure over which substantially correct reproduction is obtained. When the process is represented by an H & D curve, the latitude is the projection on the exposure axis of that part of the curve that approximates a straight line within the tolerance permitted for the purpose at hand.

Leader: Any film or strip of material used for threading a motion picture machine. Leader may consist of short lengths of blank film attached to the ends of a print to protect the print from damage during the threading of a projector, or it may be a long length of any kind of film which is used to establish the film path in a processing machine before the use of the machine for processing film.

Lens: A collection of glass elements that transmit and focus light to form an image.

Letterbox: A standard television display technique seen in many commercials and music videos. A black band on the top and bottom of the screen is used to maintain a widescreen look and preserve the original composition on a standard television screen.

Light Filter: A light-absorbing transparent sheet, commonly consisting of colored glass or dyed gelatin that is placed in an optical system to control the spectral quality, color, or intensity of the light passing a given plane.

Light Intensity: Degree of light, per unit, falling on a subject; usually expressed in footcandles.

Light Meter: An electrical exposure meter for measuring light intensity.

Light Piping: Fog caused by light striking the edge of film and traveling along the base to expose the emulsion inside the magazine or roll.

Lighting Ratio: The ratio of the intensity of key and fill lights to fill light alone.

Linear Editing: Uses a tape-to-tape method where the film is edited in the order in which it will be viewed.

Local Area Network (LAN): Network that spans a relatively small area, such as a single DI facility. It can consist of any number of computer stations and devices that are directly connected together. Every computer can access every other computer's data and any other devices inside the LAN.

Logarithmic (Encoding): Process of encoding tonal information by using a logarithmic mathematical formula. The result ends up assigning more bits of information to the darker areas of the image. This closely matches the sensitivity of the human eye, which is more discerning of the blacks and shadows of an image. It requires 10 bits to capture the complete tonal range of film logarithmically.

Long Pitch: Perforation type used on print films; slightly greater than perforations on original films to prevent slippage during printing.

Look Management: Software-based tools that help establish and manage the look of a production throughout the entire filmmaking process.

Look Up Table (LUT): Color translation table that links a set of input color values to a set of output color values. Look up tables speed up post-production processes and provide feedback in real time. Look tables are often used to implement calibration corrections, color corrections, specific looks, and color space conversions.

Loop (projector or camera): The path in which the film is formed to allow the film to travel intermittently through the gate.

Lossless Compression: Compression algorithm that reorganizes data in a more effective way to reduce file size. There is no loss of image information.

Lossy Compression: Compression algorithm that discards data considered imperceptible in order to reduce file size. Lossy compression is destructive to the original image data.

Low Key: A scene is reproduced in a low key if the tone range of the reproduction is largely in the low-density portion of the scene. Typically the subject is the brightest part of the image.

Luminance: The measured value of brightness; reflected light measure on motion picture screens as footlamberts or candelas per square meter.

Lux: Lumens per square meter. A metric measure of illuminance equal to 0.0929 footcandles (1 footcandle = 10.764 lux).

— M —

Magazine Take-Up: In the United Kingdom it is known as a spool box. It is the device, which winds up the film after photography (in a camera), copying (in a printer), and after projection (in projection).

Magenta: Purplish color; complementary to green or the minus-green subtractive primary used in the three-color process. Magenta light results when red and blue light overlap.

Manufacturer Identification Code: The letter that identifies film manufacturer. K = EASTMAN KODAK COMPANY.

Manufacturers Information: Includes information such as Year Code, Printer Number, Roll and Part Number, Emulsion Number, Product Code, Film Manufacturer.

Masking: Restricting the size of a projected image on a screen by the use of black borders around the screen. Also the restriction in size of any projected image or photographic print by the use of undercut aperture plates or masks and borders.

Master Positive (same as Interpositive): Timed interpositive made from a negative original and from which a duplicate negative is made.

Matte: An opaque outline that limits the exposed area of a picture, either a cut out object in front of the camera or as a silhouette on another strip of film.

Maximum Density (D-Max): Portion of the shoulder of the characteristic curve where further increases in exposure on negative film or decreases in exposure on reversal film will produce no increase in density.

Metadata: Additional data about a file or how it should be processed.

Midtones: The colors between black and white that occur on the straight-line portion of the characteristic curve.

Minimum Density (D-Min): Constant-density area in the tone of the characteristic curve where less exposure on negative film or more exposure on reversal film will produce no reduction in density. Sometimes called base plus fog in black-and-white film.

Modulation Transfer Function Curve: Indicates the ability of a film to record fine detail. The curve results when light transmission is measured with lines that are successively more closely spaced.

— N —

Nanometer: The unit of measure for a wavelength of light. One billionth of a meter.

Naturalism: A type of lighting that follows natural (realistic) patterns and angles.

Negative: The term "negative" is used to designate any of the following (in either black-and-white or color): (1) The raw stock specifically designed for negative images. (2) the negative image. (3) Negative raw stock that has been exposed but has not been processed. (4) Processed film bearing a negative image.

Negative Cutting: Process of cutting and splicing the original negative to match the final edited film.

Negative Film: Produces a negative image (black is white, white is black, and colors appear as complementaries).

Negative Image: A photographic image in which the values of light and shade of the original photographed subject are represented in inverse order. Note: In a negative image, light objects of the original subject are represented by high densities and dark objects are represented by low densities. In a color negative, colors are represented by their complementary color.

Negative-Positive Process: Photographic process in which a positive image is obtained by development of a latent image made by printing a negative.

Negative Timing (Negative Grading): The selection of the appropriate color correction (timing lights) for the printing process.

Negative Perforations: A generic term for the Bell and Howell perforation.

Network: An interconnected system of computers and storage devices. Computers in a network are able to work together to perform processes and share data.

Neutral-Density Filters: Used over the camera lens to reduce the intensity of light reaching the film without affecting the scene's color balance.

Newton's Rings: Fuzzy, faintly colored lines in the projected image caused by high or uneven printer gate pressure.

Nitrate Film: A highly flammable motion picture film that has not been domestically manufactured since around 1950. It is still present in large quantities in storage vaults and archives and must be very carefully stored to prevent explosions.

Noise: Random errors and fluctuations in an image. Noise can be distracting across a sequence of frames.

Non-Linear Editing: (1) Flexible form of editing where shots can be edited in a manner that do not conform to, or affect, the planned story order. (2) Editing of video and audio on a computer.

NTSC: National Television Standards Committee. The television broadcast system used in North America. Not compatible with PAL.

— O —

OMNIMAX: a widescreen format, shot on 65 mm film and projected onto specialized large, dome-shaped screens. A trademark of IMAX Corporation (see IMAX).

One-To-One Printing: Optical printing of the images which are reproduced to the same size.

Optical Effects: Trick shots prepared by the use of an optical printer in the laboratory, especially fades and dissolves.

Optical Printer: Used when image size of the print film is different from the image size of the pre-print film. Also used when titles or effects (such as skip frames, blow-ups, zooms, and mattes) are included.

Original: An initial photographic image, or sound recording—whether photographic or magnetic—as opposed to some stage of duplication thereof.

Original Camera Negative: The negative originally exposed in a camera.

Orthochromatic (Ortho) Film: Film that is sensitive to only blue and green light.

Out-Take: A take of a scene, which is not used for printing or final assembly in editing.

Output Stage: The last stage of the digital intermediate process. Typically the files in the digital intermediate are used to render a digital master. The digital master is recorded out to film and to create a variety of electronic formats.

Overcoat: A thin layer of clear or dyed gelatin sometimes applied on top of the emulsion surface of a film to act as a filter layer or to protect the emulsion from abrasion during exposure, processing and projection.

Overexposure: A condition in which too much light reaches the film, producing a dense negative or a washed-out reversal.

— P —

PAL: Phase Alternating Line. The television broadcast system used in Europe, Asia, and much of Africa. Not compatible with NTSC.

Pan and Scan: Technique used when transferring wide screen films to the standard 1.33:1 television aspect ratio. After the height of the film frame is maximized, the telecine operator pans back and forth selecting the best part of the film frame for each scene.

PANAVISION 35: A 35 mm process using 35 mm negative film and photographed through a Panavision anamorphic lens with a compression of 2X. Contact 35 mm prints are compatible with anamorphic systems such as CINEMASCOPE.

Panchromatic (Pan) Film: Black-and-white film that is sensitive to all colors in tones of about the same relative brightness as the human sees in the original scene. Film sensitive to all visible wavelengths.

Peak Density: Wavelength of maximum absorption.

Perforation Damage: On inspection the perforations through a magnifying glass you will find damage progressing from cracked, chipped or elongated holes to torn holes.

Perforations: Regularly spaced and accurately shaped holed which are punched throughout the length of a motion picture film. These holes engage the teeth of various sprockets and pins by which the film is advanced and positioned as it travels through cameras, processing machines, and projectors.

Pictorialism: A lighting method that violates natural angles for artistic effect.

Pitch: (1) That property of sound which is determined by the frequency of the sound waves. (2) Distance from the center of one perforation on a film to the next; or from one thread of a screw to the next; or from one curve of a spiral to the next.

Pixel (picture element): A pixel is the smallest unit of a bitmap image. Digital images are made up of square pixels arranged in a fixed grid. Each pixel is assigned a specific color value.

Polyester: A name for polyethylene terephthalate developed by E.I. Dupont de Nemours & Co. (Inc.). A film base material exhibiting superior strength and tear characteristics. CRONAR is the trademark name used by DUPONT; ESTAR Base is the trademark name used by Eastman Kodak Company.

Positive Film: Motion picture film designed and used primarily for the making of master positives or release prints.

Positive Image: A photographic replica in which the values of light and shade of the original photographed subject are represented in their natural order. The light objects of the original subject are represented by low densities and the dark objects are represented by high densities.

Post-Production: The work done on a film once photography has been completed, such as editing, developing and printing, looping, etc.

Primary Color: One of the light colors, e.g., blue, red, or green, that can be mixed to form almost any color.

Primary Color Correction: Primary color correction is completed first and sets the overall color balance and look of the image. It ensures that all scenes have a consistent color tone, with no sudden shifts in hue or brightness.

Print Film: Film designed to carry positive images and sound tracks for projection.

Processing: Procedure during which exposed film is developed, fixed, and washed to produce either a negative or a positive image.

Product Code: See Film Code.

Production: The general term used to describe the process involved in making all the original material that is the basis for the finished motion picture.

Projection: Presenting a film by optical means and transmitting light for either visual or aural review, or both.

Projection Speed: The rate at which the film moves through the projector; twenty-four frames per second is the standard for all sound films.

Protection Master: A master positive (MP) from which a dupe negative can be made if the original is damaged.

Pull-Down Claw: The metallic finger, which advances the film one frame between exposure cycles.

Pull Process: Using a reduced development time to compensate for overexposure, either intentional for effect or accidental.

Push Process: Using an extended development time to compensate for underexposure, either intentional for effect or accidental.

— Q —

— R —

Raw Stock: Unexposed and unprocessed motion picture film; includes camera original, laboratory intermediate, duplicating, and release-print stocks.

Reciprocity Law: Expressed by $(H)=Et$, where E is the light intensity, and T is time. When E or T are varied to the extreme, an unsatisfactory exposure can result.

Reduction Printing: See Blowdown. Making a copy of a film original on smaller format raw stock by optical printing; for example, printing a 35 mm original onto 16 mm stock.

Refraction: The change of direction (deflection) of a light ray or energy wave from a straight line as it passes obliquely from one medium (such as air) to another (such as glass) in which its velocity is different.

Release Negative: Duplicate negative or color reversal intermediate from which release prints are made.

Release Print: In a motion picture processing laboratory, any of numerous duplicate prints of a subject made for general theatre distribution.

Remjet Backing: Antihalation backing used on certain films. Remjet is softened and removed at the start of processing.

Resolution: The spatial detail of an image. For digital images, the number of pixels the image contains defines its resolution. Higher resolution images are sharper, smoother, and contain more image detail, but are also larger in file size.

Resolving Power: Ability of a photographic emulsion or an optical system to reproduce fine detail in the film image and on the screen.

Reversal Film: Film that processes to a positive image after exposure in a camera, or in a printer to produce another positive film.

Reversal Process: Any photographic process in which an image is produced by secondary development of the silver halide grains that remain after the latent image has been changed to silver by primary development and destroyed by a chemical bleach. In the case of film exposed in a camera, the first developer changes the latent image to a negative silver image. This is destroyed by a bleach and the remaining silver halides are converted to a positive image by a second developer. The bleached silver and any traces of halides may now be removed with hypo.

Rewind: An automatic console or set of bench-mounted spindles used to wind film from reel-to-reel.

Rewinding: The process of winding the film from the take-up reel to the supply reel so that the head end, or start of the reel, is on the outside. If there are no identifying leaders on the film, upside-down images will signify the head end.

RGB: A color model that combines red, green, and blue light in various intensities. Digital intermediate work is typically done in the RGB color space. It is the most common way of viewing and working with digital images on a computer screen.

RMS: Root-Mean-Square. This mathematical term is used to characterize deviations from a mean value. The term "standard deviation", which is synonymous, is also used.

RMS Granularity: Standard deviation of random-density fluctuations for a particular film.

Roll Number: This is the two-digit number that is assigned by the film manufacturer to each 6,000 ft roll.

Rough Cut: Preliminary stage in film editing, in which shots, scenes, and sequences are laid out in an approximate relationship, without detailed attention to the individual cutting points.

— S —

Safety Film: A photographic film whose base is fire resistant or slow burning as defined by ANSI and various fire codes. At the present time, the terms "safety base film," "acetate base film" and "polyester base film" are synonymous with "safety film."

Sampling Rate: The frequency at which an analog signal is measured and converted to a digital data.

Saturation: Term used to describe color brilliance or purity. When color film images are projected at the proper brightness and without interference from stray light, colors that appear bright, deep, rich, and undiluted are said to be “saturated.”

Scan Resolution: The number of pixels acquired from the original camera negative. Film scanning has three popular resolutions: Full (4K), Half (2K), and Quarter (1K).

Scanner (Film Scanner): A device used to digitize film images. Each film frames yields a separate digital image file.

Scene: A segment of a film that depicts a single situation or incident.

SD: Standard definition video.

Secondary Color Correction: Selection and manipulation of specific portions of the color spectrum or objects without affecting the overall color balance of the scene.

Sensitivity: Degree of responsiveness of a film to light.

Sensitometer: An instrument with which a photographic emulsion is given a graduated series of exposures to light of controlled spectral quality, intensity, and duration. Depending upon whether the exposures vary in brightness or duration, the instrument may be called an intensity scale or a time scale sensitometer.

Sensitometric Curve: See Characteristic Curve.

Sensitometry: Study of the response of photographic emulsions to light.

Separation Masters: Three separate black and white master positives made from one color negative; one contains the red record, another the green record, and the third the blue record.

Shadow Detail: A combination of three other image attributes, toe speed, black-level speed, and low toe contrast. An improvement in any of the attributes should lead to an improvement in shadow detail; though it can be difficult to describe shadow detail when a film has an advantage in one of the categories but a disadvantage in others.

Sharpness: Visual sensation of the abruptness of an edge. Clarity.

Short Pitch (see Perforation Pitch): The perforation pitch of a negative stock, which is somewhat shorter than the pitch of positive stock to avoid slippage in contact printing.

Shoulder: High-density portion of a characteristic curve in which the slope changes with constant changes in exposure. For negative films, slope decreases and further changes in exposure (log H) finally produce no increase in density because maximum density has been reached. For reversal films, slope increases.

Shutter: In theatrical projection, a two-bladed rotating device used to interrupt the light source while the film is being pulled down into the projector gate. One blade masks the pull-down while the other blade causes an additional light interruption increasing the flicker frequency to 48 cycles per second—a level that is not objectionable to the viewer at the recommended screen brightness of 16 footlamberts (55 candelas per square meter). In a camera, a rotating disk with a section removed.

Silver Halides: Light-sensitive compound used in film emulsions.

Single-Perforation Film: Film with perforations along one edge only.

Slow Motion: The process of photographing a subject at a faster frame rate than used in projection to expand the time element.

SMPTE: Acronym for the Society of Motion Picture and Television Engineers.

Soft: (1) As applied to a photographic emulsion or developer, having a low contrast. (2) As applied to the lighting of a set, diffuse, giving a flat scene in which the brightness difference between highlights and shadows is small.

Sound Negative: The negative record of photographic sound recording.

Sound Positive: A positive print of the photographic sound recording film.

Sourcey: The tendency for a light source to be perceived as being artificial. This artificiality is a function of the light appearing too bright or too extreme on the subject and then dropping off in intensity very quickly.

Special-Dye-Density Curve: A graph of 1) the total density of the three dye layers measured as a function of wavelengths, and 2) of the visual neutral densities of the combined layers similarly measured.

Spectral Sensitivity: The relative sensitivity of a particular emulsion to specific bands of the spectrum within the film's sensitivity range. Sometimes confused with Color Sensitivity.

Spectrum: Range of radiant energy within which the visible spectrum—with wavelengths from 400 to 700 nm—exists.

Speed: Can be characterized in terms of absolute film sensitivity or in terms of reproduced image blacks. Absolute sensitivity is simply a measure of what level of light (exposure) begins to produce the first density signal in the film – this is known as toe speed. The toe speed of a film can also be interpreted by a cinematographer as underexposure latitude or shadow detail.

The blackness of a positive image D-max can also be used to define speed. Most cinematographers would describe a film with smokier blacks as slower than a film with blacker blacks given both were exposed similarly. Black level also relates to a cinematographer's perception of shadow detail.

Speed Point: A point that corresponds to the exposure required to produce a specific optical density, usually 0.1 above base + fog.

Splice: Any type of cement or mechanical fastening by which two separate lengths of film are united end to end so they function as a single piece of film when passing through a camera, film processing machine, or projector.

Spot Meter: A light meter designed to measure light reflected from the subject.

Sprocket: A toothed wheel used to transport perforated motion picture film.

Static Electricity: Electric field that is present primarily due to the presence of electrical charges on materials.

Step: An exposure increase or decrease, usually by a factor of 2. The same as "Stop", except stop specifically refers to lens aperture. A patch of a step tablet used for sensitometer exposures, as in "21-step tablet."

Step-Contact Printer: Contact printer in which the film being copied and the raw stock are advanced intermittently by frame. Exposure occurs only when both are stationary.

Stock: General term for motion picture film, particularly before exposure.

Stop Down: To decrease the diameter of the light-admitting orifice of a lens by adjustment of an iris diaphragm.

Stop Motion: An animation method whereby apparent motion of objects is obtained on the film by exposing single frames and moving the object to simulate continuous motion.

Storage Area Network (SAN): A high-speed network that connects computer storage devices, such as hard drives and tape libraries, to servers. A SAN allows multiple computers to access a centralized pool of storage. Files can be shared, copied, or moved quickly and efficiently on a SAN.

Straight-Line Region: Portion of characteristic curve where slope does not change because the rate of density for a given log exposure change is constant or linear.

Subbing Layer: Adhesive layer that binds film emulsion to the base.

Subtractive Color: Cyan, magenta and yellow, the subtractive primaries used by film to reproduce color.

Subtractive Lighting: This technique is typically used when shooting exteriors in available light. By using large flags, butterflies, or overheads, light is removed from the subject in order to increase the lighting ratio. It is sometimes referred to as "Negative Fill."

Subtractive Process: Photographic process that uses one or more subtractive primary colors, e.g., cyan, magenta, and yellow, to control red, green, and blue light.

Sunlight: Light reaching the observer directly from the sun. To be distinguished from daylight and skylight, which include indirect light from clouds and refract the atmosphere.

Super 16: This format offers a much greater picture area than that of standard 16mm and provides a wider 1.66:1 aspect as compared to the 1.33:1 television aspect ratio.

Super 8 mm: Formerly an amateur format, now a popular choice for special effects and teaching.

Super 35: 35 mm camera format that utilizes entire frame area on film.

Supercoat: Protective coating on film.

SUPER PANAVISION: Similar to Panavision 35, but photographed flat in 65 mm. The 70 mm prints produce an aspect ratio of 2.25:1 with 4-channel sound and a ratio of 2:1 with 6-channel sound.

Sweetening: Audio post-production, at which time minor audio problems are corrected. Music, narration and sound effects are mixed with original sound elements.

Swell: The increase in motion picture film dimensions caused by the absorption of moisture during storage and use under high humidity conditions. Extreme humidity conditions and subsequent swelling of the film aggravates the abrasion susceptibility of the film surfaces.

Synchronization: A picture record and a sound record are said to be 'in sync' when they are placed relative to each other on a release print so that when they are projected, the action will coincide precisely with the accompanying sound.

Synchronize: Align sound and image precisely for editing, projection, and printing.

Synchronizer: A mechanism employing a common rotary shaft that has sprockets which, by engaging perforations in the film, pass corresponding lengths of picture and sound film simultaneously, thus effectively keeping the two (or more) films in synchronism during the editing process.

— T —

T-GRAIN Emulsion: Emulsion made up of tablet-like crystals rather than conventional silver halides crystals; produces high-speed films with fine grain. Proprietary technology developed by Eastman Kodak Company, also a trademark.

T-Stop: Like F-number, measures the diameter of the lens opening. T-stop factors in the loss of light through the glass lens elements.

Tail Ends, Tails: The end of a film. The film must be rewound before projection if it is tails out.

Take-up Reel: The reel, which the already projected film winds up on.

TECHNISCOPE: A system designed to produce 35 mm anamorphic prints from a 35 mm negative having images approximately one half the height of regular negative images and produced by using a special one half frame (2 perforation) pulldown camera. During printing, the negative image was blown up to normal height and squeezed to normal print image width to produce a regular anamorphic print that provided a projected aspect ratio of 2.35:1. The system was designed primarily to conserve negative raw stock.

Telecine: A device for transferring motion picture film to an electronic state.

Thin: As applied to a photographic image, having low density. As applied to the physical properties of film, thin base film materials provide for more film per given roll diameter.

Timing: A laboratory process that involves balancing the color of a film to achieve consistent color and density from scene to scene. Also, includes adjusting exposure settings in duplication.

Timecode: A frame numbering system adopted by SMPTE that assigns a number to each frame of video which indicates hours, minutes, seconds and frames (e.g., 01:42:13:26).

Toe: Bottom portion of the characteristic curve, where slope increases gradually with constant changes in exposure.

Tonality: Smooth transition from one tone to another (light to dark).

Tone-scale Neutrality and Linearity: The ability of a film to reproduce truly neutral gray tones from black to white (this is a function of how the contrast ratio from red to green to blue in the negative aligns with the ratios in the print). Closely correlated is the linearity of the film's characteristic curve in all three-color records from shadows to highlights. Poor linearity can lead to poor neutrality in smaller ranges of the tone-scale. Performance here can also be related to flesh-to-neutral reproduction and film latitude.

Trailer: A length of film usually found on the end of each release print reel identifying subject, part, or reel number and containing several feet of projection leader. Also a short roll of film containing coming attractions or other messages of interest.

Transmittance: Amount of incident light transmitted by a medium; commonly expressed as percent transmittance.

Travelling Matte: A process shot in which foreground action is superimposed on a separately photographed background by optical printing.

Trims: Manual printer controls used for overall color correction. Also, unused portions of shots taken for a film; usually kept until the production is complete.

Tungsten: Artificial lighting with a color temperature of approximately 3200K.

— U —

Uprezzing (Upsampling): Resizing a digital image to a larger size.

Ultraviolet Light: Energy produced by the (invisible) part of the electromagnetic spectrum with wavelengths of 100 to 400 nanometers. Popularly known as “black light.” UV radiation produces fluorescence in many materials.

Underexposure: A condition in which too little light reaches the film, producing a thin negative or a dark reversal or print.

Unsteadiness: An objectionable amount of vertical motion in the screen image.

— V —

Video Dailies: Synched videotapes with burn-in used for editing and confirming a day’s shoot.

Visual Density: Spectral Sensitivity of the receptor that approximates that of the human eye.

— W —

Wavelength: A unit of measurement, from one crest to the next, in the spectrum. Stated as nanometer (1 billionth of a meter).

Wide Area Network (WAN): A network that spans a large geographical area.

Widescreen: A general term for form of film presentation in which the picture shown has an aspect ratio greater than 1.33:1.

Winding: Designation of the relationship of perforation and emulsion position for film as it leaves a spool or core.

Workflow: A group of processes—employing hardware, software, and people—that, when put into action, delivers an end result, or a portion of an end result.

Workprint: Any picture or sound track print, usually a positive, intended for use in the editing process. A series of trail cuttings leads to the finished version of a film. The purpose is to preserve the original intact (and undamaged) until the cutting points have been established.

— X —

— Y —

Yellow: Minus-blue subtractive primary used in the three-color process.

— Z —

Zero-Frame Reference Mark: Dot which identifies the frame directly below as the zero-frame specified by both the human-readable key number and the machine-readable bar code.



Kodak

KODAK Educational Products
www.kodak.com/go/education

© Eastman Kodak Company, 2007.
Kodak, Brownie, Eastman, Estar, Keycode, Kodacolor, T-Grain,
Vision and Wratten are trademarks of Eastman Kodak Company.
Code: H-845 CAT No. 145 6144

\$39.99 USA